

A PHONOLOGICAL GRAMMAR OF NORTHERN PAME

The members of the committee approve the doctoral
dissertation of Scott Charles Berthiaume.

David J. Silva
Supervising Professor

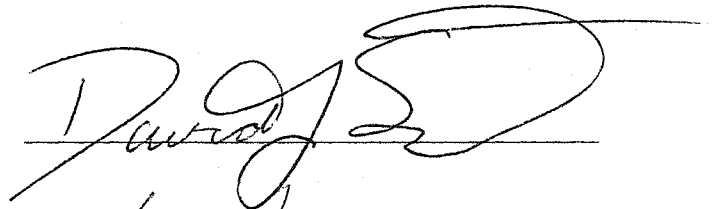

Donald A. Burquest

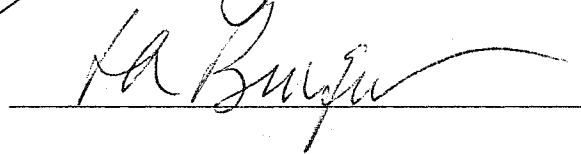

Jerold A. Edmondson

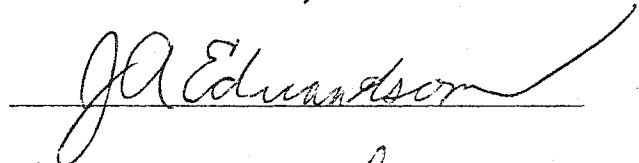

Robert E. Longacre

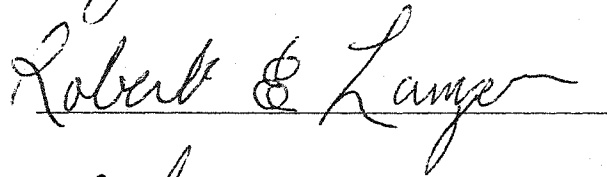

A. Raymond Elliott



Dean of the Graduate School

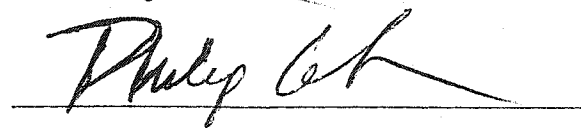

A PHONOLOGICAL GRAMMAR OF NORTHERN PAME

by

SCOTT CHARLES BERTHIAUME

Presented to the faculty of the Graduate School of
The University of Texas at Arlington in Partial Fulfillment
of the Requirement
for the Degree of

DOCTOR OF PHILOSOPHY

THE UNIVERSITY OF TEXAS AT ARLINGTON

DECEMBER 2003

UMI Number: 3138780

INFORMATION TO USERS

The quality of this reproduction is dependent upon the quality of the copy submitted. Broken or indistinct print, colored or poor quality illustrations and photographs, print bleed-through, substandard margins, and improper alignment can adversely affect reproduction.

In the unlikely event that the author did not send a complete manuscript and there are missing pages, these will be noted. Also, if unauthorized copyright material had to be removed, a note will indicate the deletion.

UMI[®]

UMI Microform 3138780

Copyright 2004 by ProQuest Information and Learning Company.

All rights reserved. This microform edition is protected against unauthorized copying under Title 17, United States Code.

ProQuest Information and Learning Company
300 North Zeeb Road
P.O. Box 1346
Ann Arbor, MI 48106-1346

**Copyright © by Scott Berthiaume 2003
All Rights Reserved**

This dissertation is dedicated to my aunt, Margo Lee Toth, who is and always will be an
inspiration to us all.

ACKNOWLEDGEMENTS

I would like to give special thanks to David Silva, my supervising professor and a simply awesome teacher. Thanks also to my other committee members Jerold Edmondson, Don Burquest, Ray Elliott and Robert Longacre

Though not as famous as the Inklings of Lewis and Tolkien, I especially thank the guys from our L'Mad dinner outings, Pete Unseth, Ervin Starwalt, David Singleton and John Evans. Thanks to all my UTA classmates including Janet Wilson, Julie May-Kolgini, Coleen Anderson and Julia Dieterman.

Special thanks are extended to my parents, Paul and Rayna, and Leon and Gloria for their love and support. Thanks to my in-laws, Andy and Dorciane, for providing me all the Sangría I wanted. I especially thank my wife, Tonia, who was incredibly patient during my many hours of study, and who always found ways to make me smile. I also thank my children, Nathan, Zachary, Mikael and Emma. I am ready to watch a video now!

When I was first accepted to the graduate program in linguistics at UTA, some friends asked me why I wanted a Ph.D. I had to think about my answer for several days and finally concluded that I wanted to be the best I could possibly be, not for myself, but as a gift to God, who radically changed my life 20 years ago. Thank you, Ade and Frannie, for helping me see clearly the purpose for all of this.

October 10, 2003

ABSTRACT

A PHONOLOGICAL GRAMMAR OF NORTHERN PAME

Publication No. _____

Scott Charles Berthiaume, Ph.D.

The University of Texas at Arlington, 2003

Supervising Professor: David J. Silva

This dissertation describes the phonology and morphology of Northern Pame, an Otomanguean language of Central Mexico. Furthermore, it explains the grammatical relationship of these domains from an Optimality Theoretic perspective.

In terms of description, Northern Pame has a complex phonological inventory of 40 consonants, which distinguish among glottalized, aspirated, voiceless and voiced segments, as well as 6 vowels, which contrast for nasalization. In addition, a claim is made for two Northern Pame tones, in contrast to earlier suggestions of a three-tone system (Avelino 1997). Regarding Otomanguean laryngeally complex vowels (Silverman 1997b, Herrera 2000), this research provides phonological, as well as laryngealscopic evidence for the segmental, rather than a unit, interpretation in Northern Pame.

Northern Pame allows for complex syllable margins, but these are severely constrained by the OCP. Syllable complex nuclei are completely forbidden, and epenthesis (*DEP) is the common strategy to resolve potential nuclei problems.

Northern Pame is morphologically complex, marking nouns for class, possession, number including dual and plural, and association. Verbs fall into two classes, each of which is sub-divided based on transitivity. Verbs and nouns share the same suffix morphology for number. Northern Pame morphophonemics encompass processes that affect place or precedence (metathesis, palatalization), laryngealization and syllable well-formedness. Under such underlying circumstances, the constraints UNIFORMITY-IO and LINEARITY-IO are the common minimal violations.

TABLE OF CONTENTS

ACKNOWLEDGEMENTS.....	v
ABSTRACT	vi
LIST OF FIGURES.....	xii
LIST OF TABLES.....	xiii
CHAPTER 1	1
1.1. Introduction	1
1.2. Location	2
1.3. Northern Pame language use	2
1.4. State of research.....	4
1.5. Research problem	5
1.6. Methodology.....	6
1.6.1. Data.....	6
1.6.2. Analysis	8
1.7. Conclusion and outline of the dissertation	9
CHAPTER 2	12
2.1. Introduction	12
2.2. Early Pamean studies: Soustelle (1934[1993]), Manrique (1967)	13
2.3. Central Pame studies: Gibson (1956), Gibson and Bartholomew (1979)	17
2.4. Northern Pame studies: Avelino (1997, 2002).	20
2.5. Laryngeal theory: Silverman (1995, 1997) and Lombardi 1994.	27
2.6. Theory: Prince and Smolensky (1993), McCarthy and Prince (1995)	35
2.7. Conclusion.....	41
CHAPTER 3	43
3.1. Introduction	43
3.2. Consonants.....	44
3.2.1. Obstruent voicing	45

3.2.2.	Aspiration and glottalization of stops and affricates	48
3.2.3.	Fricatives	52
3.2.4.	Nasals.....	52
3.2.5.	Flaps.....	56
3.2.6.	Laterals	57
3.2.7.	Glides and laryngeals.....	60
3.3.	Vowels	60
3.3.1.	Nasal Vowels.....	62
3.4.	Tone	65
3.5.	Conclusion.....	70
CHAPTER 4.....		71
4.1.	Introduction	71
4.2.	Segmentation of consonants	73
4.2.1.	Complex segments versus complex sequences	74
4.2.1.1.	The problem of consonantal ambiguity	75
4.2.1.2.	Consonant coalescence and lexical contrast.....	76
4.2.2.	Previous approach to segmentation (Avelino 1997).....	79
4.2.3.	Critique of previous approach	82
4.2.4.	The non-segmental status of ambiguous sequences.	84
4.2.5.	Additional evidence for true complex segments	88
4.3.	Segmentation of vowels.....	89
4.3.1.	Laryngeally ambiguous vowels	89
4.3.1.1.	Unit as laryngeally complex	91
4.3.1.2.	Autosegment.....	94
4.3.1.3.	Root-plus-formative.....	94
4.3.2.	Critique of former approaches.....	95
4.3.3.	Reanalysis of laryngeally ambiguous vowels.....	96
4.3.3.1.	Syllabification.....	97
4.3.3.2.	Laryngeally ambiguous vowels and tone	98
4.3.3.3.	Vowel quality	103
4.4.	Conclusion.....	105
CHAPTER 5.....		107
5.1.	Introduction	107
5.2.	Onsets	109
5.2.1.	Onset complexity.....	111
5.2.2.	/*pw/ clusters.....	114
5.2.3.	/*tj/ clusters.....	117
5.2.4.	Deletion versus coalescence	122

5.3.	Nuclei.....	124
5.3.1.	Nasal vowels.....	128
5.3.2.	Denasalization	130
5.4.	Codas	137
5.4.1.	Nasal place assimilation	139
5.4.2.	Nasal velarization	143
5.4.3.	Devoicing of Stop codas.....	147
5.4.4.	Intrusive stop formation.....	150
5.4.5.	/*wp, *jt/ but /jk/ clusters	153
5.5.	Conclusion.....	156
CHAPTER 6.....		158
6.1.	Introduction	158
6.1.1.	Anatomical overview.....	159
6.2.	Northern Pame laryngeal segment production	163
6.2.1.	Vowel initial laryngeal consonants.....	166
6.2.2.	Vowel medial laryngeal consonants.....	170
6.2.3.	Vowel final laryngeal consonants.....	173
6.3.	Conclusion.....	174
CHAPTER 7.....		176
7.1.	Introduction	176
7.2.	Noun morphology.....	176
7.2.1.	Classification	179
7.2.1.1.	N-class (default)	180
7.2.1.2.	S-class (instrumental).....	181
7.2.1.3.	Animate classes	182
7.2.2.	Possession.....	184
7.2.2.1.	J-class (ownership)	184
7.2.2.2.	n/h-class (possession)	186
7.2.2.3.	n/t-class (instrument possession).....	187
7.2.2.4.	B/R clitics (association).....	190
7.2.2.5.	Tone	192
7.2.3.	Number	193
7.2.3.1.	Dual and Plural default.....	193
7.2.3.2.	Dual and plural for possessor	195
7.3.	Verb morphology.....	197
7.3.1.	Verb classes	199
7.3.1.1.	L-D class.....	199
7.3.1.2.	L-G class.....	201

7.3.1.3.	T-D class.....	202
7.3.1.4.	T-N class.....	204
7.3.1.5.	Predicate adjectives	205
7.3.2.	Additional verbal morphology.....	206
7.3.2.1.	Modality.....	206
7.3.2.2.	Directionals.....	207
7.3.2.3.	Participles	208
7.3.2.4.	Imperatives	209
7.4.	Conclusion	211
CHAPTER 8.....		212
8.1.	Introduction	212
8.2.	Palatalization	212
8.2.1.	Glide Metathesis	213
8.2.2.	Glide-consonant coalescence.....	217
8.2.3.	Glide-Vowel Coalescence	218
8.3.	Buccalization and voicing of the feature [sg].....	224
8.3.1.	Lateral buccalization of [sg].....	226
8.3.2.	Voicing of [sg].....	229
8.4.	Coronal lateralization	231
8.5.	Glottal buccalization.....	233
8.6.	Consonant delaryngealization.....	236
8.6.1.	Deaspiration.....	237
8.6.2.	Deglottalization	238
8.6.3.	Deglottalization-devoicing	239
8.6.4.	Glottal stop voicing	241
8.7.	Conclusion	244
CHAPTER 9.....		245
9.1.	Introduction	245
9.2.	Results of the research.....	245
9.3.	Residual issues.....	247
REFERENCES		252
BIOGRAPHICAL INFORMATION		260

LIST OF FIGURES

Figure 3-1 Spectrogram of a voiceless bilabial stop in 'cow'	47
Figure 3-2 Spectrogram of a voiced bilabial stop in 'ears of corn'	48
Figure 3-3 Voiceless velar stop in 'crow'	50
Figure 3-4 Aspirated velar stop in 'they reject him'	51
Figure 3-5 Glottalized velar stop in 'piece of paper'	51
Figure 3-6 Plain alveolar nasal in 'he runs'	54
Figure 3-7 Post-aspirated alveolar nasal in 'he enters'	54
Figure 3-8 Post-glottalized alveolar nasal in 'my lice'	55
Figure 3-9 Alveolar flap in 'my bloods'	56
Figure 3-10 Plain lateral in 'he learns'	58
Figure 3-11 Glottalized lateral in 'human, man'	58
Figure 3-12 Aspirated lateral in 'they care'	59
FIGURE 3-13. Spectrogram of an oral vowel in 'influenza'	63
FIGURE 3-14. Spectrogram of a nasal vowel in 'tamale'	64
FIGURE 3-15. Waveform and pitch track for a high tone on 'your orange'	67
FIGURE 3-16. Waveform and pitch track for a low (rising) tone in 'my orange'	67
FIGURE 3-17. Waveform and pitch contour for 'my chair'	69
FIGURE 3-18. Waveform and pitch contour for 'your chair'	69
FIGURE 4-1. Contrast of oppositions (Avelino 1997:80)	81
FIGURE 4-2. Bilabial oppositions (Avelino 1997: 82)	81
FIGURE 4-3. Spectrogram of a simple /ɑ/ vowel in 'cow'	90
FIGURE 4-4. Spectrogram of a laryngeally ambiguous /u/ vowel for breathy voice in 'his chair'	90
FIGURE 4-5. Spectrogram of a laryngeally ambiguous /ɑ/ vowel for creaky voice in 'I help'	91
FIGURE 4-6. Waveform and pitch contour for 'your orange'	100
FIGURE 4-7. Waveform and pitch contour for 'my orange'	100
FIGURE 4-8. Waveform and pitch contour for 'my chair'	101
FIGURE 4-9. Waveform and pitch contour for 'your chair'	102
FIGURE 6-1. Lateral and posterior views of larynx (Lieberman 1977)	159
FIGURE 6-2. View of larynx from the apex of the epiglottis with the anterior portion at the bottom, the posterior at the top of the picture	161
FIGURE 6-3. Vocal folds during phonation and breathing with anterior portion above and posterior portion below (Pickett 1999)	163

LIST OF TABLES

Table 2-1 Comparative data for high-falling tone contrasts (Avelino 2002:22)	23
Table 2-2 Comparative data for high-low contrasts (Avelino 2002:22)	25
Table 2-3 Comparative data for low-falling contrasts (Avelino 2002:22)	26
Table 2-4 Silverman 1997:245	30
Table 2-5 Constraint ranking symbols.....	39
Table 2-6 Tableau symbols.....	39
Table 2-7 Ranking schema for phonological alternations (Kager 1999).....	40
Table 3-1 Northern Pame Consonants.....	44
TABLE 3-2. Northern Pame vowels	60
TABLE 3-3. Northern Pame tones	65
Table 4-1. Complete unit approach to Northern Pame consonants.....	71
TABLE 4-2. Complete unit approach to Northern Pame vowels.....	72
TABLE 4-3. Unambiguous compared to ambiguous segments	85
Table 4-4. Silverman 1997:245 (repeated).....	93
TABLE 4-5. Morphological tone for noun possession.....	98
Table 5-1. Possible onsets on lexical morphemes	109
TABLE 5-2. Possible onsets on lexical morphemes.....	110
TABLE 5-3. Possible nuclei in lexical morphemes.....	124
TABLE 5-4. VC [nasal] possibilities for nucleus+coda.....	130
TABLE 5-5. Northern Pame codas.....	137
TABLE 6-1. Elicitation list for glottal stops in onsets, intervocalic and coda positions.....	164
TABLE 6-2. Elicitation list for laryngeal fricatives in onsets and intervocalic positions.....	165
TABLE 6-3. Morphological paradigms involving aspirated and glottalized consonants.....	165
TABLE 7-1. Possible classifier-possession combinations	177
TABLE 7-2. Noun word constituent order	179
TABLE 7-3. Verb word constituent order.....	197
TABLE 7-4. L-D verb paradigm	200
TABLE 7-5. L-D verb examples with /kǎʔs/ ‘set. soft’.....	200
TABLE 7-6. L-G verb paradigm	201
TABLE 7-7. L-G verb examples with /əʔsúʔ/ ‘fall off’.....	202
TABLE 7-8. T-D verb paradigm	203
TABLE 7-9. T-D verb examples with /ləʔp ^h én/ ‘hit’.....	203
TABLE 7-10. T-N verb paradigm	204
TABLE 7-11. T-N verb examples with /ləʔáwʔ/ ‘be taught’.....	205
TABLE 7-12. Predicate adjective examples with /ləhín/ ‘be happy’.....	206
TABLE 7-13. Transitive imperatives	210

TABLE 7-14. Intransitive imperatives	211
TABLE 8-1. Three types of palatalization.....	213
TABLE 8-2. [+sg] as a morpheme on L-D verbs	225
TABLE 8-3. Lexical and morphological inputs for lateralization.....	232
TABLE 8-4. Buccalization of [cg] on nasal consonants	233
TABLE 8-5. Three types of delaryngealization.....	236
TABLE 8-6. Glottal stop voicing	242
TABLE 9-1. Dorsalization examples	248
TABLE 9-2. Rhinoglottophilia examples.....	249

CHAPTER 1

INTRODUCTION

1.1. Introduction

Northern Pame, an Otopamean language of the Otomanguean family (San Luis Potosí, Mexico), is phonologically and morphologically complex in all its major word classes. At the same time, this language seeks to preserve a number of universal markedness constraints such as No Complex Onsets, the Obligatory Contour Principle, the Coda Condition and the Strict Sonority Principle, which are at times in a natural conflict with faithfulness constraints of the underlying form of the language. The result is a violation of either faithfulness or markedness as a means of perserving a higher ranking constraint; the end product being the selection of the most optimal surface form. Northern Pame exemplifies this universal trade off between markedness or faithfulness violation and likewise, does so within a language specific constraint ranking.

This dissertation is an investigation into the phonological and morphological descriptive facts of Northern Pame. In addition, it is an account of the system of conflicting constraints operative in this language, a system which ultimately characterizes the linguistic competence of the native Northern Pame speakers themselves.

1.2. Location

Northern Pame is the most northern member of the Otomanguean language family of Mexico. This language group is located in the state of San Luis Potosí, 150 miles east of the state capital, San Luis Potosí in the Sierra Madre Oriental mountains.

The Pame language family includes three separate languages, which are Northern Pame (*Pame Norte de Alaquines*), Central Pame (*Pame Central de Santa María Acapulco*) and Southern Pame (*Jiliapan Pame*). Southern Pame was last documented by Manrique (1967) at which time there were only six or seven speakers in the villages of Jiliapan, Hidalgo and Pacula, Querétaro. Today, Southern Pame is extinct.

Central Pame is spoken in and around the village of Santa Maria Acapulco, San Luis Potosí. It is the most documented of the Pame languages (Soustelle 1934, Gibson 1954, 1956, Olson 1963, Gibson and Bartholomew 1979) and language use in the Central Pame region is still quite strong.

Northern Pame is spoken in villages that are clustered around three primary zones: Ciudad del Maíz, Alaquines, and La Palma. The area around La Palma has the highest concentration of Northern Pame speaking villages, the larger ones being Cuesta Blanca, Copalillos, Vicente Guerrero, Huizachal, Pozos Cuates, La Manzanilla and Agua Puerca. These villages pertain to either the municipios (i.e. county seats) of Rayon or Tamasopo, San Luis Potosí.

1.3. Northern Pame language use

The latest documentation lists Northern Pame as having between 1000 to 10,000 speakers (Ethnologue 2000), the exact number being unknown due to a high amount of

Spanish/Northern Pame bilingualism within the indigenous communities. Field notes from this researcher suggest a number of approximately 6000 speakers total.

The state of language use for Northern Pame is not promising and the language shows every sign of being moribund. A similar diagnosis was given by Soustelle two generations ago during his initial research of the language.

Una informante con quien trabajamos en Tierras Coloradas, una anciana inteligente y vigorosa, deploraba la desaparición inminente del pame y reprochaba a los demás indígenas su indiferencia o su timidez; pero ella parecía la única que tenía conciencia de la situación (1937: 333).

One informant with whom we worked in Tierras Coloradas, an intelligent and vigorous older woman, deplored the imminent disappearance of Pame and reproached the other indigenous for their indifference or their timidity; but she appeared to be the only one that had consciousness of the situation.

Another example comes from Felix Baltazar, a Northern Pame speaker who presently resides in Cuesta Blanca. Mr. Baltazar was raised speaking Northern Pame and subsequently learned Spanish at seven years of age in primary school. He describes the humiliation of constantly being behind in his studies and the ridicule of both teachers and classmates because of his 'poor Spanish', as leaving a permanent scar on his scholastic studies. When Mr. Baltazar married his wife, María de los Ángeles, they both consciously made the decision to speak only Spanish with their children so that they would not have the same experience that Felix and María did.

Some years later, Mr. Baltazar began working with educators and linguists in documenting his mother tongue. This gave him a new appreciation for Northern Pame, and he and Maria changed their philosophy of 'Spanish only' with their children. However, with three of the four already past puberty, only the youngest child was able to learn Northern

Pame well enough to speak and understand it.

Of the seven principal Northern Pame villages that surround La Palma, monolingual speakers of the language have been identified only in La Manzanilla and Pozos Cuates. In these communities, parents speak the language with one another as well as with their children. Likewise, children can be found speaking in Northern Pame with one another, although this is the exception not the rule. In the villages of Cuesta Blanca and Copalillos, adult speakers still regularly converse in the language, but with few exceptions these same speakers use only Spanish with their children.

1.4. State of research

Research of the Pamean languages began in the 18th century by early Catholic friars and was limited to the comparison of Pame data to Spanish. One such example is that from Fray Francisco Valle in his *Quaderno de Algunas Reglas y apuntes sobre el Idioma Pame*. From roughly 1920 to the present day, we find linguistic descriptions by scholars such as Soustelle and Avelino to be of a higher quality and of greater depth than those of the colonial era. From this latter period, the linguistic borders of Northern, Central and the now extinct Southern Pame were firmly established. Likewise, the basic facts related to Central and Northern Pame phonetics were documented for the first time.

Avelino's research has brought to light several morphological and morphophonemic facts specifically about Northern Pame. Regarding morphology, Avelino (1997) describes the number system for certain Northern Pame nouns, which includes both a dual and plural system. Likewise, Avelino (1995, 2002) gives considerable attention to the grammatical tone system of Northern Pame nouns. Avelino (1997) focuses on a limited, but important set of

morphophonemic processes including palatalization, dorsal mutation (*reasociación de articuladores*), denasalization (*oralización*), lateralization, epenthesis, the allomorph /s/ in the context of the dual morpheme and tone sandhi.

1.5. Research problem

Our understanding of the phonological structure of Northern Pame is still quite limited. For this reason, the present research has endeavored to clarify a number of important issues; aiming for a clear description, and ultimately incorporating the Northern Pame data into an explanatory framework. First, we lack acoustic evidence for all of the claims made about Northern Pame phonemics, with the exception of Avelino's work on Northern Pame tone sandhi (1995, 2002). In addition, there exists no comprehensive description or explanation of the syllable structure of Northern Pame, nor accounts of the Northern Pame syllable compared to other languages with regard to markedness. Such a comparison is pivotal in order to provide an account under a constraint theory, where markedness plays a crucial role.

The topic of laryngeal theory in Northern Pame has yet to be addressed, although important strides have been made with regard to laryngeals in other Otomanguean languages. Such studies carried out by scholars such as Longacre (1952) and Silverman (1995, 1998), make definitive claims regarding laryngealized vowels (VhV, VʔV) in Trique, Mazatec and Chinantec. However, it is not clear how applicable their conclusions are to other Otomanguean languages including those of the Pamean family. The segmental status of laryngeally ambiguous vowels in Northern Pame, the most Northern relative of the Otomanguean language family, is yet to be proven.

Finally, Northern Pame research is completely void of a description of its verbal morphology since we have only Avelino's (1997) description of morphological number in Northern Pame, and very little else. However, a cursory look at Northern Pame data, reveals that there is much more to be described and explained within the noun system as well.

Avelino (1997) has given us much to consider in his account of Northern Pame morphophonemics from a descriptivist perspective. However, we have no understanding of how the rich morphophonemic system of Northern Pame might be understood in light of an explanatory theory of markedness. At the same time, other domains remain completely unexplored (e.g. the alternations of laryngeal features during morphological concatenation).

1.6. Methodology

The methodology employed in this research takes two primary forms: 1) a detailed description of the language facts, and 2) an explanation of those facts within a generative framework.

1.6.1. Data

The data for this research were collected over a number of years in various places. Initial collection began while this researcher was learning to speak Northern Pame from 1997 to 1999. Further field work was conducted during the summer and winter of 2000, the summer of 2001 and the spring of 2002. These field trips were made in the Northern Pame villages of Las Guapas, Puerto Verde and Cuesta Blanca from two primary Northern Pame colleagues, Felix Baltazar Hernandez and Atanacio Gonzales. In addition, the data were tested with various other inhabitants in the communities to insure accuracy of the phonetic transcription.

Early in the field work, it became evident that the phonological system of Northern Pame was quite complex, and included a great deal of morphophonemics. Likewise, it was clear that the data published in the research up to that time were not comprehensive enough to produce a data corpus sufficient for this dissertation. Therefore, this research focused on the elicitation primarily of nouns and verbs and their morphological alternations. Besides words elicited from texts and language learning notes, this research depended greatly on the noun and verb paradigm notes collected by Lorna Gibson for Central Pame; a corpus which contains 220 noun paradigms and 139 verb paradigms. A form was elicited in Spanish in a sentence frame followed by the same word in isolation.¹ All data used in the acoustic sections in this dissertation were digitally recorded.

As part of this research, a laryngealoscopic examination of a Northern Pame speaker was conducted in order to obtain video recorded data on the production of laryngeally ambiguous vowels; these vowels are quite similar phonetically to those documented for other Otomanguean languages (Longacre 1952, Silverman 1997b). The laryngealscope, an imaging device with a flexible fiber optic tip originally designed by Sawashima and Hirose in 1968. The specific device used was a Kay Elemetrics Rhino-Laryngeal Stroboscope 9100 with a package halogen light source, an Olympus ENF-P3 fiber optic laryngealscope and a Panasonic KS with 152 camera and 28 mm wide angle lens. S-VHS video recordings were made and later digitized for computer use. The fiber was inserted through a nostril and lowered into the pharyngeal cavity, just above the apex of the epiglottis. Once positioned,

¹ Audio recordings were made with Marantz PMD-222 professional audio cassette recorder with built in microphone. Digital recordings were obtained with a Dell 4100 Inspiron laptop computer with a Labtec C-322 headset microphone. The data were recorded and edited using Speech Analyzer 15.2. They were further transcribed in phonetic form and stored as a database in Speech Manager 1.5.

the subject uttered a list of Northern Pame words that contrasted /ʔ/ and /h/ vowel initially, vowel medially and between vowels (with the exception of vowel final /h/, which does not occur in the language).²

1.6.2. Analysis

The theoretical approach to language taken in this dissertation is essentially Generative (Chomsky 1957, 1966, Chomsky and Halle 1968), which attempts to account not only for the descriptive facts or use of a language (performance), but also the tacit knowledge of the native speaker/hearer in his ability to infinitely create new strings of linguistic structure (competence). This deeper linguistic knowledge is said to reflect the existence of a universal grammar innate among the human species. The Generative model utilized here is a constraint based theory known as Optimality Theory (Prince and Smolensky 1993). Optimality Theory assumes that all constraints in grammar are universal in form and that only their relative ordering is language specific. The job of the native language learner is not one of learning language-specific constraints (or rules for that matter), but rather this information is largely preconditioned. Rather, the language learner needs only to learn the relative order of the constraints involved in his mother tongue, which consequently provides him with the information needed to produce an infinite number of well-formed phonological surface forms.

²This research was led by Dr. Jerold A. Edmondson in coordination with Dr. John Esling at the University of Victoria and Speech Technology Research Ltd., Victoria B.C., Canada. It was supported through Dr. Edmondson with the Department of Linguistics at the University of Texas at Arlington, and through Dr. Esling with a grant from the Social Sciences and Humanities Research Council of Canada (#410-93-0539).

1.7. Conclusion and outline of the dissertation

Northern Pame is characterized by short words, a high amount of contrastive segments on the lexical root including 40 consonants, 12 vowels and two tones. The syllable may contain complex onsets and codas, while only simple (single vowel) nuclei are allowed. Margin non-complexity can and often is preserved by invoking certain kinds of violations with the surface form of coalescence or deletion. Northern Pame is also characterized by a complex system of laryngealization, which manifests itself among vocalic as well as consonantal segments.

With regard to the morphology of the language, Northern Pame utilizes a classification system for its nouns and an equally diverse system of noun possession. Number may be morphologically marked as dual or plural on both nominal, adjectival, and verbal elements.

Northern Pame verbs are morphologically distinguished by their degree of transitivity in the form of two major verb classes. Verbs are likewise marked for subject and, incomplete, complete and potential aspect. Subject person is marked in a portmanteau relationship with the subject prefix, while dual and plural number is marked with suffixes.

Northern Pame morphophonemics involve alternations related to place with such surface forms involving processes such as palatalization, lateralization and buccalization of laryngeal features. Furthermore, laryngeal features alternate with one another in processes such as deaspiration, deglottalization and the voicing of glottal stops. Finally, certain syllable constraints are preserved, for example, by the deletion of certain consonants in suffixes

The organization of this dissertation commences from small elements (phones and features) to larger ones (morphemes) and concludes at the level of morphophonemics. Chapter 2 is a summary of the research on Pame languages as they pertain specifically to linguistic questions. The most important of these is Avelino's 1997 bachelor's thesis, which is the only linguistic research specific to Northern Pame. Additionally, research on other Pamean languages is summarized with essential properties common to all Pame languages highlighted. The second half of chapter summarizes several important works on laryngeal theory and concludes by explaining the fundamental claims and formalisms used in Optimality Theory.

Chapter 3 provides a phonemic statement on all contrastive segments and suprasegments in Northern Pame. Furthermore, this chapter provides acoustic illustrations of many of the types of laryngeal and tonal contrasts that have been previously documented only superficially in transcription form. Chapter 4 deals specifically with the issue of consonant and vowel segmentation in Northern Pame, two issues which have only been superficially dealt with previously. In this chapter, it is claimed that all complex segments as outlined by Avelino (1997: 82) should be accepted with the exception of palatalized bilabials argued for by this research. In addition, it is claimed that labialized velars, labialized and palatalized laryngeals should be interpreted as sequences. The second half of chapter 4 makes the crucial claim that VhV and VʔV (laryngeally ambiguous vowels), which in other languages have been described as complex breathy and creaky vowels, are best understood as a sequence of vowel-laryngeal-vowel.

Chapter 5 describes the syllable phonotactics and the constraints that govern them. In

particular, we find that complexity is allowed on syllable margins in some cases, but that often a simple margin is preferred at the expense of various faithfulness constraints. Chapter 6 contains the results of an laryngealoscopic study of laryngeally ambiguous vowels. These results lend articulatory support to the claim in chapter 4 of the sequential status of these elements. Chapter 7 is an exhaustive description of the essential nominal and verbal morphology of Northern Pame. Chapter 8 further describes the phonological shaping that occurs when these morphemes concatenate to the lexical root in Northern Pame. These processes are further explained within an Optimality theoretic. Chapter 9 summarizes the results of this study, their implications, and provides discussion on a number of issues that require further investigation.

CHAPTER 2

LITERATURE AND THEORY

2.1. Introduction

There are a number of important works that have contributed to a foundational understanding of Pamean languages.³ Soustelle (1934[1993]) was the first to systematically describe Pame in light of typological evidence, while Manrique (1967) documented the then moribund (and now extinct) Southern (Jiliapan) Pame. The observations made by these researchers were further developed in Gibson's meticulous study of Central Pame phonemics and morphophonemics (1956) and Gibson and Bartholomew's (1979) description of Central Pame noun inflection. Northern Pame linguistic documentation since Soustelle has been most recently completed by Avelino (1997, 2002), who focused on Northern Pame dialectology, segmental phonology and tone.

From a theoretical perspective, this dissertation has much to owe to Silverman (1997a, 1997b) and Lombardi (1994) in addition to many others in the area of laryngeal phonology. Silverman's 'phasing and recoverability' hypothesis focuses on the sequencing of laryngeal features on the major classes of phonological segments. Likewise, his research on Otomanguean laryngeally complex vowels has a direct consequence on Northern Pame

³ For a comprehensive list of early Pamean studies other than those summarized here, see Soustelle (1993), Manrique Castañeda (1967) and Avelino (1997).

laryngeal segmentation in chapter 4. Lombardi's central claim of a laryngeal node and its delinking in laryngeal neutralization is also worthy of mention and will be returned to in chapter 8.

Finally, the present research is largely cast within the theoretical framework of Optimality Theory (Prince and Smolensky 1993, McCarthy and Prince 1995). Based on the premise of universal grammar, this approach allows us to stipulate markedness constraints as universal, yet violable under the notion of constraint ranking so that a constraint may be violated if a conflicting constraint is ranked higher in the phonology of a language. Such a view of grammars has the advantage of relating them based on their markedness patterns.

2.2. Early Pamean studies: Soustelle (1934[1993]), Manrique (1967)

The early 20th century research by Jacques Soustelle (1934) marks the first real attempt to describe Pame languages within a framework of general linguistics and typology. He accomplishes this task by extensive field work that covers five primary languages within the Otopame family including various dialects of Otomi (Querétaro and Hidalgo), Mazahua (Mexico State), Matlazinca (Mexico State), Chichimeca (Guanajuato) and Pame (San Luis Potosí). The data on all of these languages enabled Soustelle to make important observations about their phonology, morphology and syntax. The discussion that follows summarizes his observations regarding Northern Pame phonology and morphology.⁴

Although his research was the most valuable on Northern Pame at the time, Soustelle did not hesitate to confess his utter bewilderment with the Northern Pame data facts that

⁴ Soustelle made no distinction of Pame languages, only dialects. The Northern Pame discussion referred to here was termed Pame Alaquines (340), which was named after Alaquines, San Luis Potosí where Soustelle obtained his data. The Alaquines dialect is very similar to the Northern Pame data collected by this author from Cuesta Blanca (Municipio Tamasopo) 20 miles south.

confronted him. In his presentation of Northern Pame phonetics, we find the following statement regarding the perception of Mestizos regarding the difficulties of the Pame language.

En la región septentrional los indígenas son numerosos; su lengua tiene fama de ser extraordinariamente difícil, si no imposible, de pronunciar correctamente y, al contrario de lo que ocurría en territorio otomí, los no indígenas ni siquiera intentan aprender unas palabras (339).

In the northerly region the indigenous people are numerous; their tongue is famous for being extraordinarily difficult, if not impossible, to pronounce correctly, and contrary to what occurs in the Otomi territory, the non-indigenous people do not even try to learn some of the words.

The chapter is full of similar statements about the complexities of the language, whether they be phonological or morphological. For example, in presenting data on nouns and the recurrence of what appear to be classifiers he mentions:

Es posible que estas partículas se refieran a un sistema de clasificación, pero cuando se considera un número bastante alto de palabras, se ve que la misma partícula puede aplicarse a palabras que designan objetos muy diversos...(340).

It is possible that these particles refer to a system of classification, but when the high number of words is considered, it can be seen that the same particle can apply to words that designate very diverse objects...

Soustelle's instinct that these particles were classifiers was actually correct, but it so happens that he had the misfortune of gathering a large number of irregular paradigms.⁵

⁵ This can be seen in the comparison he makes between the unmarked and first person possessor form for the Nahuatl loan word for 'deer'.

Soustelle (1993:340)
masat 'deer'
nsat 'my deer'

Regarding the phonetics of the language, he mentions that Northern Pame is quite complex with its consonantal codas (339). In fact, in his typological survey, Pame surpasses all other languages in Otopame syllable margin complexity. He also noted the free variation that existed between alveolar affricates and velar stops. In fact, today we find that this variation to be one of major phonological distinctions between Northern and Central Pame.

As to morphology, Northern Pame is no less challenging according to Soustelle. This can be seen with his statement about possessive nouns.

Innumerables veces hemos encontrado ya este tipo de pronombre, tan característico del otomí, el mazahua, etc. En nuestra opinión, es muy natural que un pronombre (así como un verbo) varíe de acuerdo con la persona y el número; pero que estos dos factores rijan toda una serie de variaciones muy complejas en

Morphologically, we can see that /mα-/ alternates with /n-/ for the possessive form while the stem /-sat/ remains constant. In the following, the full morphological paradigm for 'deer' is given with the correct morpheme breaks. Notice that there is more morphology here.

CLASS	POSSESSOR	ROOT	STEM	
		/masat/	/masat/	'deer'
/n-/	/ʔw-/	/sat/	/nʔsat/	'my deer'
/n-/	/ej-/	/sat/	/nəʃat/	'your deer'
/n-/	/ʔj-/	/sat/	/nʔʃat/	'his deer'

What was unknown to Soustelle is that unlike all other nouns, animals must have n-class classifiers when possessed, while their unmarked forms vary. Any other n-class noun conjugates like the following.

CLASS	POSSESSOR	ROOT	STEM	
/n-/		/k'əʃ/	/nk'əʃ/	'piece of paper'
/n-/	/ʔw-/	/k'əʃ/	/nʔk'wəʃ/	'my piece of paper'
/n-/	/ej-/	/k'əʃ/	/ntʃ'əʃ/	'your piece of paper'
/n-/	/ʔj-/	/k'əʃ/	/nʔtʃ'əʃ/	'his piece of paper'

In this example, the same classifier surfaces on the unmarked form as well as the possessive form.

los sustantivos es un hecho mucho menos corriente (343).

Countless times we have found this type of pronoun, so characteristic of Otomi, Mazahua, etc. In our opinion, it is very natural that a pronoun (just like a verb) varies in agreement with person and number; but that these two categories completely spread an entire series of complex variations in the nominals is much less common.

The fact that Pame has person and number agreement between pronouns and verbs provides Soustelle with no intuitive difficulty. However, he considered it quite marked that the language would insist on person and number categories for nouns.

Compared to his description of nouns, Soustelle had much less to say on the issue of verbs. He gives us one “abstract” paradigm for the verb ‘to see’ to illustrate certain stem changes (355). However, he does touch on two important facts here. One is that the palatal glide is a very productive verbal morpheme and moreover, that the third person plural is characterized by some type of segmental modification of the initial root consonant.⁶

In his contribution to *The Handbook of Middle American Indians*, Manrique Castañeda (1967) writes an introductory description of Jiliapan Pame, which at the time of his paper had only “five or six persons able to speak it” (331). Although Jiliapan Pame is a variety of Southern Pame, there are a number of common “Pamean” characteristics that are worth pointing out.

With regard to phonology, Jiliapan Pame has laryngeally ambiguous vowels where the same vowel quality is bifurcated with either a glottal stop or a laryngeal fricative.

(1) /ntihin/ 'corn dough'

⁶ In fact, the presentation on verb classes shows that in these circumstances a feature morpheme of spread glottis ([+sg]) is the most productive type.

/mūhū/ 'pumpkin'

Manrique Castañeda interprets these as sequences of segments, rather than as integral units (see discussion in chapters 3, 4 and 6). Likewise, he describes the voiced stops as being susceptible to intervocalic weakening (i.e. b → β etc.), while surfacing as full voiced stops after homorganic nasals (334).

(2) /sibich'i/ [siβich'ì] 'lime'

/numbúʔu/ [numbúʔu] 'wooden hammer'

Manrique Castañeda mentions that Jiliapan Pame has three tones: high, low and falling (334). These tones are only contrastive on stressed syllables. Although he does not say so explicitly, stress appears to be predictable on the lexical root of a word. He, also comments that unstressed vowels "tend to be more or less obscure, increasing the difficulties of phonemic interpretation" (335).

Finally, Manrique mentions that Jiliapan Pame has no instance of tone functioning to mark grammatical categories as is common place in the other Pamean languages. Likewise, possession is indicated with separate pronouns rather than with grammatical tone.⁷

2.3. Central Pame studies: Gibson (1956), Gibson and Bartholomew (1979)

Gibson's 1956 article on (Central) Pame phonemics and morphophonemics is an extremely detailed work and remains the most comprehensive phonemic statement on any Pame language. In the introductory paragraph, she states,

⁷ With only five or six speakers, all of whom converse in Spanish this is not surprising. In fact, in my interviews with Northern Pames it was found that the possessive forms were the first to be forgotten by those who did not speak the language regularly. Whether Southern Pame had possessive nouns or not is a question that will unfortunately never be answered.

Special attention of the reader is called to the unusual vowel system, the heavy consonant clusters, the great variety of syllable patterns, the combination of tone and stress and the wealth of morphophonemic changes (242).

Regarding vowels, Gibson claims that Central Pame has just one back vowel, /o/. Her data findings reveal that no contrasts between the high back vowel /u/ and /o/ can be found and in fact, these tend to vary allophonically (242). She later notes that /o/ is subject to deletion between certain vowels and a coda /p/. Likewise, she maintains that the vowel, which other Pameanists call a low-back vowel is better understood as a front-low vowel, which varies allophonically with its back counterpart.

In describing the tone system, Gibson makes reference to syllable duration (244). Specifically, short syllables (i.e. “fast”) have a high tone-stress, while long syllables (i.e. “slow”) have a low or falling tone-stress. Likewise, Gibson finds tone to be contrastive only on stressed syllables, which is predictably the lexical root.

Gibson draws attention to an interesting observation that “before a homorganic nasal in final clusters /b d g/ have allophones which are articulated very slightly and rapidly” (245). The data she gives is the following.

(3) Voiced stops before a homorganic nasal (Gibson 1956:245)

STEM	SUFFIX	DERIVED FORM	
/rothwàn /	/-bmʔ/	/rothwàmʔ/	'our.Ex.corn'
/rothwàn /	/-dn/	/rothwàn/	'our.In.corn'

/ta'wá/	/-bmʔ/	/ta'wáb mʔ/	'our.Ex.hearts'
/ta'wá/	/-dn/	/ta'wá dn/	'our.In.hearts'

This topic has been taken up in Berthiaume (2000) where it is suggested that such a pattern is one of partial denasalization or 'delayed velum lowering' of a nasal consonant following an oral vowel. Under this proposal, these are not voiced stops at all but simply prestopped nasal consonants.⁸

The gnawing problem of noun possession in Central Pame morphology is taken up in Gibson and Bartholomew (1979). The authors make a number of important observations about the co-occurrence restrictions of possessive morphology in Central Pame, which are described below.

Gibson and Bartholomew describe Central Pame nouns as inflected for number of the noun, number of the possessor and person of the possessor (309). These categories are morphologically marked in a number of ways, which include prefixation, consonantal alternation of the lexical root, tone and suffixation. The choice between prefixation and suffixation is largely based on the semantic category of animacy. Inanimate nouns use prefixes and animate nouns use suffixes as in the respective examples /ngo-dèocʔ/ 'bridge' and /manèp/ 'my chin'. In addition, the authors mention that possessive tone morphology is productive on noun stems that are not marked with inflectional suffixes (309).

⁸ The principal arguments for a denasalization process is that Pame never allows voiced obstruents in coda position. If Gibson's approach is taken, there is a difficult exception to this generalization about the syllable structure of Pame. In addition, these 'stops' are never orally released, but rather the air stream is rapidly redirected via a lowering of the velum.

Regarding possessive tone, Gibson and Bartholomew observe that in these cases, the second person tone tends to be different from the first or third person (312). Thus, they suggest three patterns to predict possession morphology, 1) ABC, 2) EFE, and 3) XXX. In the ABC pattern, the second person can be the same or different from the first and third. In the EFE pattern, the second person is always different. In the XXX pattern, tone has no change in any possessive form (312-313).

Although this article provides helpful insights regarding the general tendencies of Pame noun possession, these same insights tend to get obscured by the morass of phonetic detail in the data. Thus, Gibson and Bartholomew provide us with the morphological framework, but the subsequent morphophonemic processes are still left largely unexplained.

2.4. Northern Pame studies: Avelino (1997, 2002).

Avelino's bachelors thesis (1997) encapsulates much of the previous discussion on Pamean languages and focuses it specifically on Northern Pame. At the time of Avelino's publication, no other Northern Pame linguistic research of depth had been done since that of Soustelle (1934).

As mentioned above, the issue of consonant segmentation in Pame is an important one. Avelino points out that the location of highest consonantal contrast in a Northern Pame word is the initial position of the lexical root (111). This is a common situation in languages, especially where morphology is concerned and Pame languages exhibit a tremendous amount of prefix morphology. Indeed, Avelino critiques the strict segmental sequence approaches asserted by Castañeda (1967) and Gibson (1956), which these authors take for granted as true without any justification. Because of their predisposition for a purely segmental sequence

view, generalizations about Pame morphophonemics are left largely unexplained.

The solution that Avelino proposes is that of two kinds of oppositions following the Prague School tradition outlined in Trubetzkoy (1939). These oppositions may be lexical, as in the traditional phoneme or they may be morphological. What this solution implies is that these two domains can co-exist somewhat independently and somewhat dependently. Specifically, Avelino asserts that lexical contrasts are free to be usurped by morphological contrasts, but not vice versa (80).

The practical application of Avelino's two opposition approach has some beneficial consequences. For example, let us look at the issue of palatalization on lexical root initial consonants. If the consonant is an alveolar stop, it will palatalize to an alveolar affricate. These are in a lexical opposition. That is, alveolar stops *and* alveolar affricates appear in analogous lexical *and* morphological environments. On the other hand, a palatalized bilabial stop exists only in a morphological environment. Thus, it is unique in that it is in a morphological opposition with a plain bilabial stop.

Avelino's approach depends entirely on the types of contrasts found in his data corpus. That is, it is based on what kinds of phonemes exist in what environments. This issue of lexical and morphological contrasts turns out to be less clear cut than Avelino asserts. In fact, the data given in this dissertation illustrate that there are few clear cases of morphological only oppositions (see chapter 4). Rather, most of the morphological oppositions Avelino claims to exist are shown in this research to exist also in lexical oppositions, therefore limiting the usefulness of the two opposition model.

Avelino's (1997) discussion on Northern Pame tone is recast in Avelino (2002) and is

the source upon which the present discussion will be based. This work is the most extensive study to date on Northern Pame tone and laryngealization.

Avelino (2002), like Manrique Castañeda (1967) and Gibson (1956) makes the phonological claim that Northern Pame has three contrastive tones (high, low and falling).⁹ He documents that a high tone is basically a level pitch ranging between 130-170 Hz and 220-290 Hz respectively for male and female speakers (24). A low tone has a pitch range of approximately 95-120 Hz and 120-190 Hz for males and female speakers respectively. It should be noted that Avelino claims that low tone may have a moderate level of laryngealization (25). Regarding falling tone, Avelino claims that male speakers range from a high pitch falling to around 40 Hz, while female speakers begin at high range and fall to approximately 60 Hz. Likewise, Avelino mentions that falling tone samples, ‘ilustra la imagen de los tonos descendentes ‘rearticulados’ (27), ‘illustrate the image of rearticulated falling tones.’ That is, a falling tone often has a rearticulation of a glotal stop between the high a low phase of the tone such as in /nt^hɛ̃/[nt^hɛ̃ʔ̃] ‘tamale’.¹⁰

This dissertation presents Northern Pame tone and its relationship to laryngealization in a very different light and in fact, the very topic of tone sequencing with laryngeal gestures plays an important role in three chapters. Specifically, the present research claims that there exist only two contrastive tones in Northern Pame; a high tone and a rising tone. The phonetic correlate for a high tone is identical to that of Avelino. However, a rising tone is quite distinct in that the duration of the vowel bearing the tone is lengthened up to 300 ms.

⁹ Avelino (2002:21) mentions one source, Gibson, Olson and Olson (1963) who claim that Central Pame has a fourth (rising) tone. Evidently, Gibson later returned to the three tone analysis in Gibson and Bartholomew (1979).

¹⁰ Whether this is a compensatory lengthening process in addition to vowel rearticulating is unclear.

compared to an average of 150 ms for a high tone (male speaker). Additionally, in the present research no level low tone exists.¹¹ Finally, evidence is given to support the claim that laryngealization, either glottalization or laryngeal frication, is not derived from underlining tonal causes, but rather is phonemic in nature and should be viewed as an idiosyncrasy in the structure of the language.

It is important at this juncture to examine Avelino's empirical support for his (and others') claim of the three tones of high, low and falling. All of Avelino's data represents lexical tone contrasts. In table 1, we see Avelino's contrasts for a high versus a falling tone. These examples are identical with data elicited by the author. The comparison shows significant differences in the contrasts represented.¹²

Let us examine the kinds of differences that are contained in the two data samples. First, Avelino interprets falling tone as in variation with a vowel interrupted with a glottal gesture (a-b, c-d, i-j, r-s), a predictable allophonic process (2002: 27). However, the data facts in this dissertation research suggest that the glottal stop is a phonemic segment in these examples.¹³

Table 2-1 Comparative data for high-falling tone contrasts (Avelino 2002:22)

¹¹ A secondary support of the non-existence of a low level comes from literacy. Northern Pame speakers find it extremely difficult to intuit anything other than a rising contour with obligatory length. In addition, see discussion in chapter 3 on why a vowel length analysis is unacceptable.

¹² This data was recorded using Speech Analyzer 1.5 with a stationary headset microphone. The Northern Pame speaker was Felix Baltazar Hernandez, the same male speaker used by Avelino (1997, 2002).

¹³ The logical outcome of Avelino's claim would be that root intervocalic glottal stops should not exist with low pitch, but in fact they do as for example in *npǎʔaj* [npǎʔáj] 'my animal' and *nĩʔíp* [nĩʔíp] 'plane'. Another fact that suggests the segmental nature of these glottal stops is the identical distribution of laryngeal fricatives, both with high and low pitches such as *n^hpúhu* [n^hpúhu] 'your chair' and *n^hpúhu* [n^hpúhu] 'my chair'.

AVELINO		CONTRAST TYPE	BERTHIAUME	CONTRAST TYPE	
a.	/-péʔ/	High	/péʔ/	High	'he stones'
b.	/-pêʔ/	Falling	/péʔə/	High, bisyllabic	'he kisses'
c.	/nts'és/	High	/nts'és/	High	'nerve'
d.	/nts'ê/	Falling	/nts'ésə/	High, bisyllabic	'skinny'
e.	/nú/	High	/núʔu/	Homophonous	'he sees'
f.	/nû/	Falling	/núʔu/	Homophonous	'to wake up'
g.	/səlhúʔt/	High	/səlhúʔt/	Oral	'deaf'
h.	/səlhûʔt/	Falling	/səlhúʔt/	Nasal	'shirt'
i.	/sút/	High	/súʔut/	High, bisyllabic	'he breaks'
j.	/sût/	Falling	/sút/	High	'to arm (v)'
k.	/komú/	High	/kəʔmũ/	Rising, oral	'sister in law'
l.	/gəmə/ [gəməʔu]	Falling	/gəʔmũʔ/	High, nasal	'turtle'
m.	/nt ^h éʔ/	High	/nt ^h æʔæ/	Oral	'influenza'
n.	/nt ^h êʔ/ [nt ^h éʔè]	Falling	/nt ^h æʔæ/	Nasal	'tamale'
o.	/nəp/	High	/næʔæp/	High, /æ/	'liver'
q.	/nêp/ [néʔèp]	Falling	/nĩʔĩp/	Rising, /ĩ/	'plane'
r.	/gəp ^h é/	High	/gəp ^h é/	High	'pig'
s.	/gəp ^h ê/ [gəp ^h éʔe]	Falling	/gəp ^h éʔe/	High, bisyllabic	'fly'

The second type of contrast is important in that it is one of an oral vowel versus a nasal vowel (g-h, m-n). In both cases, the facts in this research are that these are minimal pairs for nasalization, while Avelino's analysis regards these as tonal contrasts.¹⁴

The third difference is found in examples (e-f), where Avelino maintains that these roots are homophonous. In fact, examples (e-f) illustrate the classic case of a difference in transitivity in L-D versus T-D verb class morphology (see chapter 7). What is at work is that

¹⁴ See chapter 3 for spectrograms. Notice the washing out of the first formant in 'tamale', the primary acoustic correlate for nasalization (Stevens 2000: 193)

the root for both 'he sees' and 'he wakes up' is /núʔu/. The transitive meaning (L-D morphology) means 'he sees', while the same root with an intransitive meaning (T-D morphology) means 'he wakes up'. As for the root itself, there is no contrast whatsoever. Finally, examples (k-l, o-q) are forms that this author found to have a contrast of a rising tone versus a high tone rather than a high versus a rising tone.

Moving on to Avelino's high-low contrasts, we see data contrasted with this research in Table2-2..

Table 2-2 Comparative data for high-low contrasts (Avelino 2002:22)

	AVELINO	CONTRAST TYPE	BERTHIAUME	CONTRAST TYPE	
a.	/-tá/	High	/-tǎ/	Nasal	'to wash'
b.	/-tǎ/	Low	/-tá/	Oral	'to hug'
c.	/-pá/	High	/-pǎ/	Oral, æ	'he waits'
d.	/-pǎ/	Low	/-pá/	Nasal	'he visit'
e.	/-páí/	High	/-páj/	High	'to send'
f.	/-pǎi/	Low	/-pǎj/	Rising	'to help'
g.	/-k ^h uát/	High	/-k ^h wát/	High	'to keep'
h.	/-k ^h oǎ/	Low	/-k ^h uǎ/	Rising	'foot'

The contrasts found by this researcher are either of oral versus nasal vowels or high versus rising tone. Hyphenated words indicate a verb root without person/tense, aspect morphology.

Finally, Avelino lists the following pairs as contrasts for high versus falling tone.

Table 2-3 Comparative data for low-falling contrasts (Avelino 2002:22)

	AVELINO	CONTRAST TYPE	BERTHIAUME	CONTRAST TYPE	
a.	/-tâ/	Low	/-tá/	Oral	'to hug'
b.	/-tâ/	Falling	/-tâ?ã/	Nasal, bisyllabic	'to wash dishes'
c.	/-pâ/	Low	/-pá/	Nasal	'to visit'
d.	/-pâ/	Falling	/pæ?æ/	Oral, bisyllabic	'he counts'
e.	/ntîŋ/	Low	/ntĩŋ/	Rising	'a type of red plant'
f.	/ntîŋ/	Falling	/ntíŋ/	High	'jarras'
g.	/-k ^h oâ/	Low	/-k ^h wã/	Rising	'foot'
h.	/-k ^h úâ/	Falling	/-k ^h wãt/	Rising, /t/	'to fix'
i.	/hès/	Low	/-hès/	Homophonous	'scissors'
j.	/-hès/	Falling	/-hès/	Homophonous	'to whistle'
k.	/t̃s'û/	Low	/t̃s'ú/	Nasal	'his mother'
l.	/t̃s'ûl' /	Falling	/t̃s'ú?ul' /	Oral, bisyllabic root	'to bite'
m.	/t̃samà/	Low	/t̃samá/	Monosyllabic root	'he left again'
n.	/tamâ/	Falling	/tamá?α/	Bisyllabic root	'I agree'
o.	/lè/	Low	/l'æ/	Monosyllabic root	'man'
q.	/lê/	Falling	/læ?æ/	Bisyllabic root	'to step'

The data in table 3 represent more of the same kind of differences as those illustrated in tables 1 and 2. One exception should be pointed out with example (h), which this author discovered to have a root final /t/.

In summary, Avelino (1997, 2003) provides us with the first collection of data facts and analysis of the Northern Pame language. In addition to establish clearly establishing the fundamental differences between Northern Pame and its other Pamean affiliates, his research has made strides in identifying the complex phenomenon of Pame grammatical tone via a

three tone hypothesis. This dissertation research, however, discovered slightly different facts to those documented by Avelino for three Northern Pame phonemic tones and as will be further established in later chapters, suggests that the language has only two contrastive tones.

2.5. Laryngeal theory: Silverman (1995, 1997) and Lombardi 1994.

The purpose of Silverman's 1995 dissertation (published in 1997) on phonological perception is to establish a functional link between recoverability and markedness (viii). He mentions that articulatory timing, or "phasing" relationships ensure auditory salience. Thus, his is a study in perceptual salience, not articulatory ease. There are four forms of phasing relationships that Silverman discusses and tests: 1), gestures may be temporally sequenced with respect to one another, 2) a gesture may be temporally expanded so that it precedes and follows another gesture, 3) a gesture may be temporally truncated with respect to another gesture, or 4) there may be parallel production where gestures are produced simultaneously (viii). A basic tenet in Silverman's theory of laryngealization is that, "to the extent that gestures can overlap without obscuring contrastive information, they do overlap" (11).

An outline of Silverman's dissertation is (1) introduction, (2) previous work and formalism is as follows. Laryngeal gestures and phasing are then split up into those with obstruents (3), sonorants (4) and vowels (5). Specific highlights will be summarized on the last three areas.

Regarding laryngeal phasing with obstruents, Silverman introduces the idea of phasing with examples of aspirated stops. Aspirated stops cannot be phased in parallel fashion, because aspiration would not be optimally reached. Rather, based on studies of

others such as Kingston (1985, 1990) in his *binding hypothesis*, it has been shown that laryngeal articulations are “more tightly bound to the release of a stop than to the release of a continuant (3).”

It should be noted that the transition around the offset of a stop, unlike that of a continuant, is an acoustically salient event particularly well-suited to encode contrastive information. Continuants, however, are more or less acoustically uniform from onset to offset (3).

The binding hypothesis has a number of interesting consequences, one being that glottal release is sequenced to follow oral release in ejectives (44).¹⁵ Laryngeal sequencing with fricatives is considered much more marked.

Unlike plosive releases, fricative releases are virtual images of their onsets, as air continually flows across the glottis and out of the mouth. Apart from stridents no appreciable build-up of air pressure takes place, and consequently, there is no burst on to which a laryngeal may ‘bind’ (59).

Regarding /s/+consonant clusters, Silverman mentions that stops are more salient when released into a vowel, but sibilants, more than any other class, are cued primarily by their target constriction and secondarily by the onset and offset of the gesture. Thus, these gestures are re-sequenced to optimize their salience (6).

Moving on to laryngeal gestures and sonorants, Silverman mentions that some languages cross-classify contrastive phonation (aspiration and/or laryngealization) with nasals. The combination of laryngeal gestures to nasals may render the place of articulation non-recoverable (10). His claim is that laryngeal abduction occurring with a nasal stop reduces intensity and obscures the formant structure of the nasal. This may make the

¹⁵ See chapter 3 for this type of articulation in Northern Pame.

segment's place indiscernible. Because of this, the laryngeal gesture is truncated compared to supralaryngeal gestures, sequenced to precede voicing. In other words, while aspirated stops normally involve post aspiration, voiceless nasals involve early realization of the laryngeal feature (69), usually in the form of preaspiration. Likewise, glottalized nasals tend to have the laryngeal gesture phased much earlier than stops.

Regarding laryngeal features and laterals, Silverman maintains that because laterals are articulatorily and acoustically distinct from other classes of constrictions, they do not run the risk of being confused with any non-laterals. Thus, a voiceless lateral should enjoy a relatively free and varied realization (85). Specifically, in Otomanguean languages Silverman claims that laterals, either abducted or constricted, are implemented as [non-modal voice] followed by [modal voice].

Finally, Silverman presents a perceptual analysis of laryngeally complex vowels, which he claims derive from a language that cross-classifies tone and phonation (5). Languages that have no contrastive tone are free to implement breathiness and creakiness throughout most of the duration of the vowel (11-12). However, a central claim of Silverman is that when tone is involved, laryngeal sequencing may take place.

...tone is most salient when occurring with modal voice. Consequently, in laryngeally complex vowels tone and non-modal phonation are sequenced, produced serially, so that tone may be realized with modal voice (92).

However,

...in the case of (non-tonal) breathy or creaky vowels, both laryngeal and supralaryngeal configurations may be implemented fully simultaneously, so no contrasts are jeopardized (11-12).

With regard to breathy vowels and aspirated consonants, Silverman makes the strong claim that it is the marked case that the two will co-occur (143). He cites languages such as Chong and Huautla Mazatec as languages that have aspirated stops and breathy vowels, yet restrict their co-occurrence. In the case of Mazatec for example, the language *does* have pre-aspirated stops before breathy vowels, but never post-aspirated stops in that environment (102). Although pre-aspirated stops are themselves quite marked, such markedness is considered more optimal than the alternative of having post-aspirated stops directly in front of a breathy vowel and running the risk of a loss of perceptual recoverability.

Silverman's phasing and recoverability hypothesis is further elaborated in Silverman (1997).

Table 2-4 Silverman 1997:245

	PREVOCALIC	POSTVOCALIC	INTERRUPTED
JALAPA MAZATEC	hVɿ, ʔVɿ	-	-
COMALTEPEC CHINANTEC	hVɿ, ʔVɿ	Vhɿ, Vʔɿ	-
COPALA TRIQUE	hVɿ, ʔVɿ	Vhɿ, Vʔɿ	VhVɿ, VʔVɿ

Silverman describes three Otomanguean languages, 1) Jalapa Mazatec, 2) Comaltepec Chinantec, and 3) Copala Trique with regard to their interaction of non-modal phonation (breathy voice and creaky (glottalized) voice) and tone. His claim is that

phonatory principles at work in Otomanguean languages (in contrast to the Tibeto-Burman language Mpi) are strongly implemented to such an extent that the language is forced to pattern optimal timing patterns for non-modal voice (236). Mazatec has only prevocalic laryngealization, Chinantec has both pre- and postvocalic laryngealization and Trique adds to those, *interrupted* laryngealization. Typologically, a language with post will also have pre-, while if one has interrupted, it must also have pre- and post-laryngealization.

Furthermore, Silverman discusses data from two languages that seem to counter his premise that these gestures' (of non-modal voice and pitch) very incompatibility may be contributing to their de facto sequencing (247). Mpi (Tibeto-Burman) is shown to have non-modal voice and pitch, but no ordering sequencing. Silverman maintains that on phonetic grounds, non-modal voice in Mpi is *lighter* to the point that concomitant tone is still recoverable even though non-modal phonation occurs throughout the duration of the vowel. For the language Tamang, he can only speculate since there is insufficient acoustical data on the language to know for sure (251-254). He finishes by offering some type of formal account of this typology with reference to Liljencrants & Lindblom's (1972) model of equidistance of vowel space which was based on the articulatory features of the tongue, lip, jaw and larynx (255). Silverman suggests that a computational model might be able to predict when a language might have enough laryngeal complexity that alternate timing patterns would emerge.

Silverman aims to develop a model to account for non-modal voice constrictions in Otomanguean languages. His fundamental claim is that sound systems typically maximize the perceptual distinctness among their contrastive values, which is mediated by natural

biological constraints on the involved articulators and the auditory system. When an underlying phonology becomes too complex with regard to laryngeal articulations, these languages create a timing pattern for non-modal voice (1997:237).

However, his claim that laryngeal sequencing is a general pattern in Otomanguean, when only three Otomanguean languages are represented in his data set is overstated. More disconcerting, however, is his claim that tone is the principal cause of laryngeal sequencing in these languages. How do we know that breathy and creaky voice is an underlying feature in these languages if they are always sequenced with tone so that their surface representations are indistinguishable from glottal stops and laryngeal fricatives? How do we determine that these are not just laryngeal segments? His claim is further weakened by the fact that languages do exist where non-modal phonation and tone co-occur. Even more difficult to explain, however, are those languages with laryngeal sequencing that do not possess tone (e.g. Isthmus Mixe (Herrera , p.c.)) How can these be explained if tone is not even a factor?

In *Laryngeal features and laryngeal neutralization* (1994), Lombardi sets out to explain laryngeal neutralization as a process of laryngeal node delinking. She deals specifically with the topics of the laryngeal features of obstruents, the feature [voice] and voicing assimilation, glottalization and aspiration, and the laryngeal phonology of sonorants.

Regarding laryngeal features and obstruents, Lombardi summarizes previous theories that have been put forth (Halle and Stevens (1971), Lisker and Abramson (1964)) with the focus of her discussion centering around Kingston (1990) and his binding hypothesis.¹⁶

¹⁶ Simply stated, the Binding Hypothesis says that laryngeal distinctions are bound to the release of an obstruent and that laryngeal distinctions will behave differently in sounds that have no release, such as fricatives and sonorants (12).

In her theory of laryngeal neutralization, Lombardi considered the feature [voice] as privative rather than simply underspecified. Second, there is no contrast between a bare laryngeal node and no laryngeal node at all. Thus, it is preferable to have one node that delinks. Third, languages that have laryngeal neutralization have the following constraint: [voice] is allowed only before a [+son] in the same syllable. Fourth, Lombardi mentions that languages can have a specific rule in word medial clusters where voice is spread from the second member, a prevocalic consonant, to the first, a postvocalic consonant. This is later referred to as a spreading process of the entire laryngeal node rather than feature spreading. Fifth, Some languages have a laryngeal constraint except in word final position similar in nature to extrametricality.

Lombardi establishes her main claim by tying the voice constraint to the laryngeal processes of glottalization and aspiration. Thai is a good example of the laryngeal constraint. Thai has voiced stops, voiceless stops and voiceless aspirated stops. However, only /ptkʔ/ occur syllable finally, thus demonstrating that more is at work than simply devoicing. Lombardi appeals to a process of delaryngealization, which can be motivated with a constraint that prohibits the entire laryngeal node syllable finally.

One language that appears to be an exception to laryngeal node delinking is Tol. Tol has voiceless, glottalized and voiceless aspirated stops, yet only plain and aspirated occur word finally. If glottalization is neutralized word finally, why not aspiration? Here, Lombardi argues that the facts are spurious. She prefers to interpret word final aspiration as release (99). "Since it seems likely that the authors have simply erroneously identified the release of the final stop with aspiration,...." Likewise, Bengali and Marathi appear to be

exceptions where languages have voiceless, voiced, voiceless aspirated and voiced aspirated phonemes. In these languages, there is no aspiration contrast word finally, but voiced stops are permissible. Tojolabal has a contrast between plain and voiceless glottalized stops. However, glottalized consonants cannot close a word internal syllable. She explains these exceptional cases as one of word final exceptionality.

Finally, Lombardi discusses why Kingston's Binding Theory is not compatible with the facts that she has outlined (135-6). First, voicing, unlike other laryngeal features, is not realized on release. Yet, all laryngeal features (she claims) pattern together. Second, fricatives pattern with obstruents rather than sonorants. Since fricatives can devoice, yet have no release, and while laryngeal features pattern with voice, it seems plausible that the laryngeal node is not dependent on a release node.

Lombardi makes the strong assumption that voiceless sonorants are in fact, underlyingly aspirated (Mester and Itô 1989, Clements 1985) (151). One reason is that many languages that have an aspiration distinction in obstruents also have a distinction in sonorants (9 out of 16 in Maddieson 1984). In addition, the languages that have an aspiration contrast for sonorants, but not for obstruents are suspect. She cites Mongolian and Irish as examples where this is an allophonic distinction only.

Therefore, regarding the neutralization of sonorants, Lombardi claims that aspirated sonorants will neutralize to plain voiced sonorants if the language has that contrast. The rest of the chapter looks at two scenarios: 1) languages that have the constraint on obstruents only, and 2) those that have the constraint on obstruents and sonorants.

Lombardi's challenge to the binding hypothesis (Kingston 1990) is clearly an appeal

to abstraction that has some merit. Her claim that laryngeal features such as aspiration and glottalization should distribute in similar patterns with voicing is motivated by cross-linguistic data and has the advantage of explaining a wider range of neutralization processes without being encumbered by surface detail. However, her theory needs further justification by a still broader corpus of language facts that have well documented laryngeal complexity and adequate detail regarding their phonotactic properties.

2.6. Theory: Prince and Smolensky (1993), McCarthy and Prince (1995)

The concept of constraints as an impetus for triggering rules has evolved into a completely constraint-driven phonological model known as Optimality Theory. Central to this approach is the idea of cross-linguistic markedness as the primary motivation for any and all constraints. Optimality Theory follows the lead of Autosegmental Phonology in taking into account the phonetics in the phonology and to limit abstraction of the underlying representation. However, whereas the Structuralists insisted on a phonetic realization of the phoneme and the classical Generativists allowed the underlying representation (UR) to be as abstract as an analysis required, Optimality Theory follows neither of the two views completely. Under this model, the ranking of constraints relative to one another distinguishes individual grammars, while the constraints themselves are considered to be universal.

Optimality Theory places all constraints into one of two categories: markedness constraints or faithfulness constraints. With reference to markedness, it has been recognized for many years (see Jakobson 1941, Chomsky and Halle 1968) that there are structures that are preferred cross linguistically while others are not. For example, among the world's

languages, CV syllables are universal while VC syllables are restricted to a smaller class of languages. Furthermore, if a language has VC syllables, it will always have CVC and V syllables. Likewise, certain segments tend to be more marked than others. No language is known to exist that does not have a series of voiceless stops, but voiced stops vary among languages and are considered to be marked.

Faithfulness constraints preserve the underlying contrast in a language's (including, but not exclusively) grammatical system including the phonology. It is assumed, that in the event of counter-evidence, those elements that are underlyingly contrastive will always surface in the output.

Both markedness constraints (either context free or context sensitive) and faithfulness constraints are in natural conflict in a given phonology. If a language were completely faithful to the underlying representation, it would be highly marked cross-linguistically. Likewise, if a language were completely unmarked cross-linguistically, it would be extremely unfaithful to its own underlying representations. Therefore, Optimality Theory assumes that the only way to resolve this conflict is for higher ranked constraints to be preserved at the expense, or violation of lesser ranked constraints.

In an Optimality proof or 'tableau', there is a single string in the input (equivalent to an underlying representation) and a list of possible candidates in the output (equivalent to a phonetic representation). This direct mapping from input to output means that Optimality Theory does not refer to levels of abstraction. One of the output candidates is considered 'optimal' in the sense that it violates the least ranked constraint compared to any of the other possible candidates. Thus, OT considers the list of possible output candidates to be infinite,

yet there will only be one winner.

Ranking priority is formally illustrated from left (high) to right (low). The order of the constraint ranking is language specific, while the constraints themselves are universal. Let us look at a fictional example in (4).

(4) Constraint ranking example

Constraint A, Constraint B >> Constraint C

In this example, constraints A, B, and C are ranked so that A and B dominate C. Constraints A and B are in a non-ranked relationship to one another (indicated by a comma), while both are ranked above C (indicated by >>). This ranking implies that if there is a conflict between either constraint A or B with C, C will be the one to be violated under the principle of economy, “banned options can only be banned minimally” (Kager 1999: 21).

The constraint ranking in (4) is graphically represented in the tableau in (5).

Looking at this example tableau we can make several observations. First, there is the underlying form represented to the left of ‘input’.

(5) Example of tableau formalism

Input	/X/	Constraint A	Constraint B	Constraint C
a.	[candidate X]	*!		
b.	[candidate Y]		*!	
c. ☞	[candidate Z]			*

This is the same as the underlying form in classical generative phonology. To the right of the input form is the list of markedness constraints or faithfulness constraints in a particular order.

A partial list of output candidates is given below the input and these are evaluated by the constraint ranking and their violations of constraints are listed in each's respective row. The output candidate that has the most minimal constraint violation (the most rightward) is considered not the perfect choice, but the optimal choice.¹⁷ Tables 2-5 and 2-6 list the symbols and their meanings when used in an OT tableau for those unfamiliar with OT formalisms.

There are several implications that make Optimality Theory a more adequate model than those discussed thus far. First, constraints in this theory only apply to output candidates, not to input ones making it a less abstract. This is in contrast to the classical Generative definition of a class of constraints known as Morphological Structure Constraints (MSC), which prohibited certain structures at the morpheme level (Kager 1999:19). Such a representation in Optimality Theory is known as 'richness of the base.' Second, Prince and Smolensky (1993:192) maintain that the input should be the same as the output unless there is evidence to the contrary in what is termed 'Lexicon Optimization.' What this in fact does, is insure that faithfulness will be minimally violated and not needlessly so.

¹⁷ In all of the OT analyses in this dissertation, the entirely faithful candidate (the candidate identical to the input) will be listed as candidate (a).

Table 2-5 Constraint ranking symbols

RANKING SYMBOLS	MEANING
>>	'separates two ordered constraints'
,	'separates two unordered constraints'

Table 2-6 Tableau symbols

TABLEAU SYMBOLS	MEANING
Input	'underlying form'
☞	'winning candidate'
slashes	'input'
*	'constraint violation'
*!	'fatal constraint violation'
Solid vertical line	'separates two ordered constraints'
Dotted vertical line	'separates two unordered constraints'

An interesting correlate to Lexicon Optimization is that the correct ranking of constraints should choose the optimal candidate even when the input is negatively represented for a given feature or segment (Kager 1999:32). This failsafe lends additional strength to the model.

Likewise, a central concept to OT is the factorial typology, which is a re-ranking of a set of constraints in a tableau. Because the claim of OT is that languages differ only with respect to constraint ranking, not the constraints themselves, any re-ranking of a tableau must give only attested grammars (Lombardi 1995:2). If not, one or more of the constraints is suspect. Kager (1999:36) gives the following ranking schema and their phonological

equivalent based on constraint types slightly adapted below.

Table 2-7 Ranking schema for phonological alternations (Kager 1999)

CONSTRAINT RANKING	PHONOLOGICAL ALTERNATION
MC-context free >> MC-context sensitive, Faithfulness	Lack of variation (unmarked)
MC-context sensitive >> MC-context free >> Faithfulness	Allophony
MC-context sensitive >> Faithfulness >> MC-context free	Positional neutralization
Faithfulness >> MC-context sensitive, MC-context free	Full contrast

Therefore, coupled with lexicon optimization, OT has two independent means of checking itself.

Optimality Theory provides a number of improvements over the American Structuralist, Generative and Non-linear approaches. First, it freely represents contrasts in a segmental or featural framework, thus easing the abstraction problem. In fact, a constraint theory relaxes the burden of the underlying representation to provide the correct surface form. With this, constraint ranking obviates the need for multiple derivations such as those in Lexical Phonology. Second, Optimality Theory provides the means to deal with the universality problem of constraints. In pre-constraint theories, constraints were assumed to be universal, yet empirically they were shown to be tendencies, not absolutes. Optimality Theory explains this by assuming that constraints, while universal, are violable. Thus, there is no need to stipulate a constraint's operation, like a rule, but only to demonstrate its violation due to a conflict with a higher-ranking constraint. Universal constraints are cross-

linguistic tendencies, due to language specific rankings, not stipulation. Third, Optimality Theory allows more phonetics to be in the underlying representation. This is a crucial difference from Underspecification Theory that posited that redundant features were underlyingly valueless. Contrastively, a constraint approach allows for redundant features to be present in the input, as they are in the output, but to be ranked below contrastive features. Finally, Optimality Theory is able to mix the phonological component with the grammatical component in a theoretical transparent way via constraint ranking. This is an improvement over a morphophonological rule or stratal derivation because the same machinery (i.e. the ranking of constraints) that is used for purely phonological alternations such as allophony, can be exploited to include non-phonological domains.

2.7. Conclusion

From Soustelle to Avelino there are a number of recurrent observations in Pamean languages. First, Pame has contrastive tone on the stressed syllable only, while all other tones are predictable. Second, consonant clustering and consonant modification in morphology is quite productive. Finally, within the domain of morphology, one of the most dominant themes in Northern Pame is the use of person and number on both verbs and nouns. But much work remains to be done, even within the areas that these authors have addressed. Specifically, Northern Pame tone facts in this research suggest the presence of a rising tone with compensatory lengthening and the absence of a falling tone. Likewise, we lack a clear understanding of where to draw the line between true consonant clusters and true complex segments. The phonotactics of Northern Pame phonemes have yet to be fully mapped out. Last and perhaps most importantly, the complexities of morphology and morphological

processes within Northern Pame concatenative phonology still remains largely unexplored.

From a theoretical perspective, laryngeal theory as expounded in research by Silverman (1995, 1997) and Lombardi (1994) touch on some salient facts of Northern Pame. Silverman's claim that VʔV and VhV phonetic sequences are underlyingly laryngeally complex vowels in Otomanguean languages remains to be tested on other languages within this family. Northern Pame is an excellent choice in this regard, since it is one of the more peripheral Otomanguean languages both geographically and typologically. Lombardi's proposal of a laryngeal node as an active factor in laryngeal neutralization also finds welcome data in this present research where laryngeally complex consonants and coda neutralizations are commonplace.

Finally, the descriptive facts of Northern Pame phonology, and in particular the facts described in the following chapters, should be adequately explained in terms of what we know to be true of all languages (i.e. universal grammar). Such an explanation can be attained in any number of ways, both formal and non-formal. Optimality Theory is a model that is built around the central claim that languages share universal constraints, and that such constraints are in a natural conflict thus causing certain ones to be violated. Assuming these presuppositions are true, an Optimality theoretic offers the means to separate language specific preferences from universal characteristics in the phonology of Northern Pame.

CHAPTER 3

CONTRASTIVE SEGMENTS

3.1. Introduction

This chapter presents phonemic segments that exist in Northern Pame. The consonant system is made up of 40 segments in all with place features for labial, alveolar, post-alveolar and velar. In addition, laryngeal distinctions are significant in Northern Pame with alveolar and velar stops, for example, contrasting for voice, aspiration and glottalized, a rather marked situation typologically (Ladefoged 1982: 255).

The vowel system is less complex with regard to vowel quality. However, one idiosyncrasy related to Pame is the presence of only one back-round vowel, which in the case of the Northern Pame is the vowel /u/. Although only two back vowels exist, there are four front vowels in addition to the central schwa vowel. All Northern Pame vowels may be nasal or oral.

Northern Pame tone can be either high or rising. High tone is always rapid and slightly falling, while rising tone has marked compensatory vowel lengthening when there is no sonorant coda for the stressed syllable nor a rightward syllable.

Finally, in order to discover phonemic sounds, one must determine if certain ambiguous combinations of sounds make up one unit or are a sequence of several phonemes (i.e. segmentation). As it turns out, this is a very complex question for Northern Pame and is

a topic which is taken up in chapter 4 *Segmentation*.

3.2. Consonants

Northern Pame has the following consonant inventory.

Table 3-1 Northern Pame Consonants

	BILABIAL	ALVEOLAR	ALVEO-PALATAL	VELAR	LARYNGEALS
STOPS	/p/ /b/	/t/ /d/		/k/ /g/ /ʔ/	
	/p ^h /	/t ^h / /t'/		/k ^h / /k'/	
AFFRICATES		/tʃ/	/tʃʰ/		
		/tʃ ^h / /tʃ'/	/tʃʰ/		/tʃ'/
FRICATIVES		/s/	/ʃ/		/h/
NASALS	/m/	/n/		/ŋ/	
	/m ^h / /m'/	/n ^h / /n'/	/ŋ ^h /	/ŋ'/	
FLAPS		/r/		/r ^j /	
LATERALS		/l/		/ɬ/	
		/l ^h / /l'/	/ɬ ^h /	/ɬ'/	
GLIDES	/w/			/j/	

Northern Pame consonants are quite numerous with 40 segments in total. Among the stops there is a four way contrast for voiceless, voiced, aspirated, and glottalized¹⁸. Bilabial stops do not contrast for glottalization, but do for voicelessness, voicing and aspiration. There are two contrastive places of articulation for affricates, which are alveolar and post-alveolar. Affricates contrast for aspiration and glottalization, but not voicing. Fricatives contrast for either alveolar or post-alveolar and can only be voiceless. The sonorant consonants may be nasals, laterals and an alveolar flap. The nasals and laterals contrast for voice, aspiration and glottalization, while the flaps contrast only for place. The glides may be voiced bilabial or palatal semivowels. The semivowels do not contrast with the high vowels /iu/, and therefore, they are considered be high vowels that surface as consonants under certain syllable conditions. The laryngeals may be either a stop /ʔ/, or a fricative /h/.¹⁹

3.2.1. *Obstruent voicing*

Northern Pame stops are the only segments in the consonant inventory that are contrastive for voice. This contrast is applicable for bilabials, alveolars and velars.

¹⁸ The term 'glottalized' is used to specifically refer to consonants produced with air trapped between a closed glottis and some supralaryngeal articulator.

¹⁹ Laryngeals have alternately been interpreted as glides (Halle 1992, Burquest and Payne 1993, Kenstowicz 1994). However, there seems to be no overwhelming reason (phonological or phonetic) in Northern Pame to do so.

(1) /p/~b/, /t~/d/, /k~/g/

VOICELESS		VOICED	
/péʔæp/	'he helps him'	/bæʔæp/	'they help him'
/pəgás/	'cow'	/bəsǎ/	'ears of corn'
/təʔsúʔ/	'I fell off'	/dəkwónʔ/	'he dragged'
/təlún/	'chicken'	/dəl ^h ún/	'it is finished'
/kəʔpáʔs' /	'hot-inside house'	/gəp ^h ě/	'pig'
/kəsǎwt/	'shade'	/gusé/	'seed'

The contrast between a voiceless stop and a voiced stop is one of periodic vocal fold vibration as can be seen in figures 3-1 and 3-2 with word-initial contrastive bilabials. The voiceless stop has complete occlusion of airflow before the following vowel, which is graphically illustrated on a spectrogram by 1) zero vocal fold vibration, 2) a complete lack of vowel formant structure, and 3) immediate voicing at the transition from the release of the bilabial stop to the vowel (indicated by a clear vertical line where vocal fold vibration initiates). These properties are all present in figure 3-1, with the addition of a drop in frequency for F1 and F2 right at the stop/vowel transition, which is caused by labial constriction.

In contrast, a voiced stop has oral tract occlusion with simultaneous vocal fold

vibration. Looking at the voiced bilabial stop in figure 3-2, vocal fold vibration never ceases from the voiced stop into the vowel. At the stop/vowel transition, lip rounding is indicated with a drop in F1 and F2 as in figure 3-1 and formant structure is present indicating the place features of the vowel. An allophonic property of Northern Pame voiced stops is that these freely vary with voiced fricatives phones $[\beta\delta\gamma]$ intervocalically and often word initially. However, their distinctiveness is clearly one of voice, not frication.

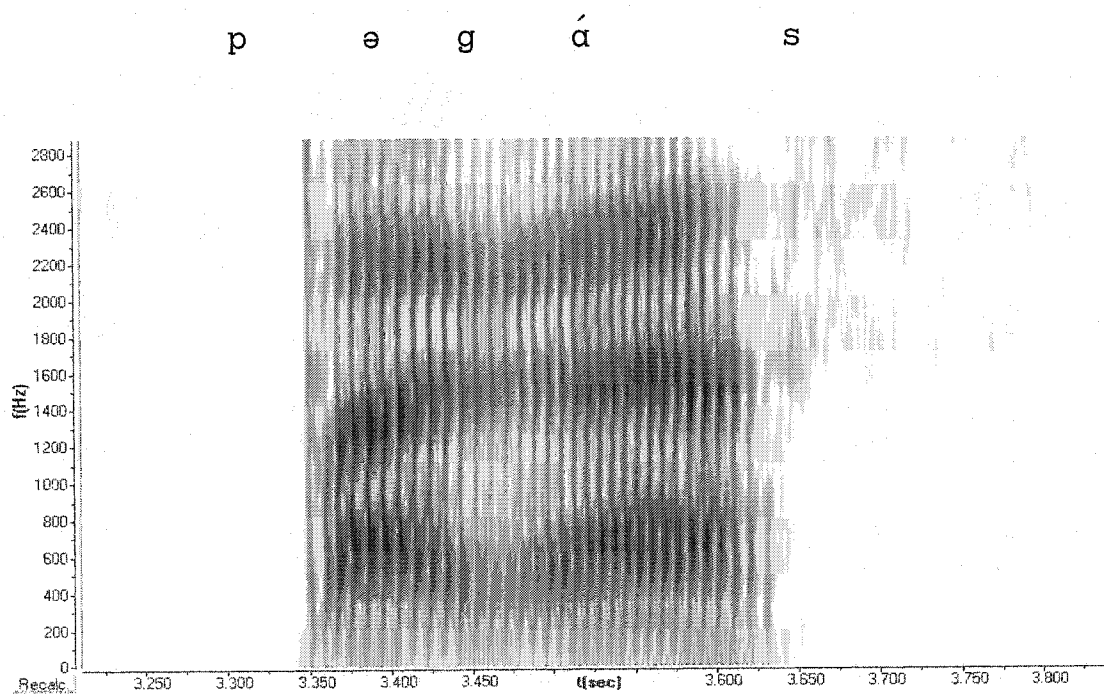

Figure 3-1 Spectrogram of a voiceless bilabial stop in 'cow'

b e s ã

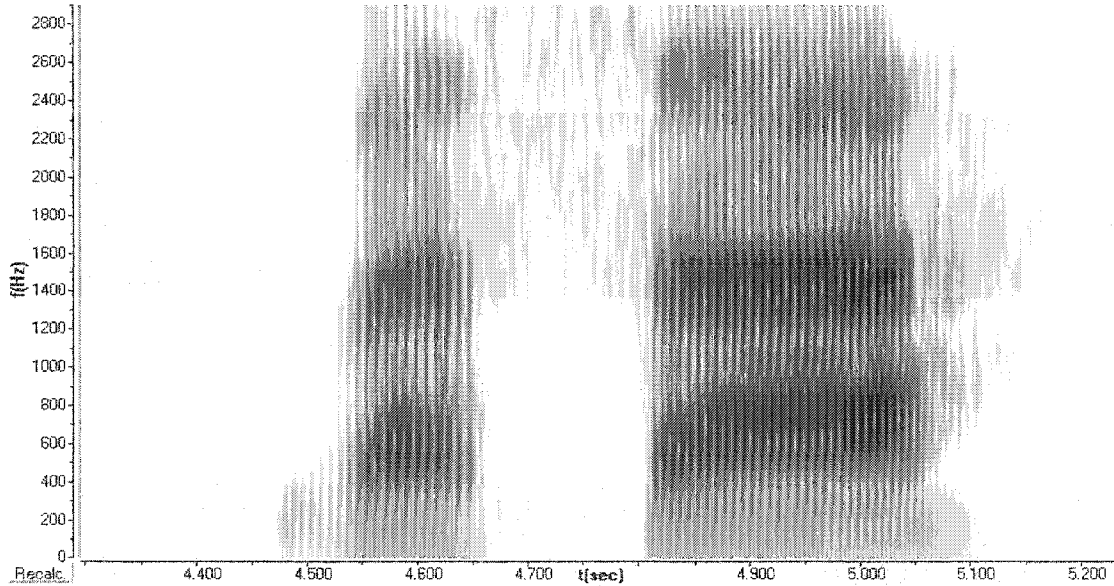

Figure 3-2 Spectrogram of a voiced bilabial stop in 'ears of corn'

3.2.2. *Aspiration and glottalization of stops and affricates.*

Northern Pame stops and affricates can be aspirated or glottalized.²⁰ As an example of laryngealization on consonants, let us look at the contrast between plain, aspirated and glottalized velar stops. Acoustically speaking, the difference between a voiceless and aspirated segment is primarily one of voice onset time.

²⁰ The one exception is that Northern Pame lacks /p' /.

(2) /p/~p^h/, /t~/t^h/~/t'/, /k~/k^h/~/k'/, /t͡s~/t͡s^h/~/t͡s'/,

/t͡ʃ~/t͡ʃ^h/~/t͡ʃ'/

PLAIN		ASPIRATED		GLOTTALIZED	
/kəʔpáʔs/	'hot.place'	/ləʔp ^h én/	'he hits'		
/npǎhal' /	'horse'	/np ^h úhu/	'chair'		
/ntún/	'flower'	/nt ^h ú/	'chili'	/st'wǎʔ/	'sheep'
/kəntǎw/	'his face'	/nt ^h ǎʔǎ/	'influenza'	/nt'ǎ/	'mesquite tree'
/nkǎʔ/	'crow'	/k ^h úp/	'they reject him'	/k'wǐn/	'he tires'
/nkúp/	'I rejected'	/nk ^h wǎ/	'rabbit'	/nk'éʃ/	'piece of paper'
/t͡séʔ/	'he takes it'	/t͡s ^h én/	'they wash'	/t͡s'éʔ/	'lime'
/mǎt͡sǐ/	'pitcher'	/guts ^h éʔ/	'snake'	/nt͡s'ǎwn/	'avocado'
/t͡ʃǎʔ/	'clearings'	/t͡ʃ ^h úl' /	'mirrors'	/t͡ʃ'ás/	'bananas'
/pit͡ʃǎʔ/	'corn storehouse'	/kəʔt͡ʃ ^h í/	'your blood'	/t͡ʃ'éʔ/	'pots'

Figures 3-3 and 3-4 illustrate this contrast with a voiceless velar stop in 'crow' and an aspirated velar stop in 'they reject him'. The voiceless velar stop begins occlusion at approximately .600 on the time axis with its release and subsequent burst at .775 with vocal fold vibration for the following vowel at .800. The duration from the burst to voicing for the voiceless stop in 'crow', that is the voice onset time (VOT), is approximately 25 milliseconds

compared to the aspirated stop in 'they reject him', which has a VOT of approximately 100 milliseconds.

The difference between a voiceless and glottalized consonant is one of air stream mechanism type. Whereas a voiceless segment is produced with pulmonic air flow through the glottis, a glottalized segment is produced with glottalic air, or air that is trapped between closed vocal folds on the one hand, and some oral tract closure on the other (Clark and Yallop 1995:17).

The example in figure 3-5 illustrates a Northern Pame glottalized velar stop. In Northern Pame glottalized stops, there are two distinct releases; first a release for the oral tract constriction followed by the release of the glottis.

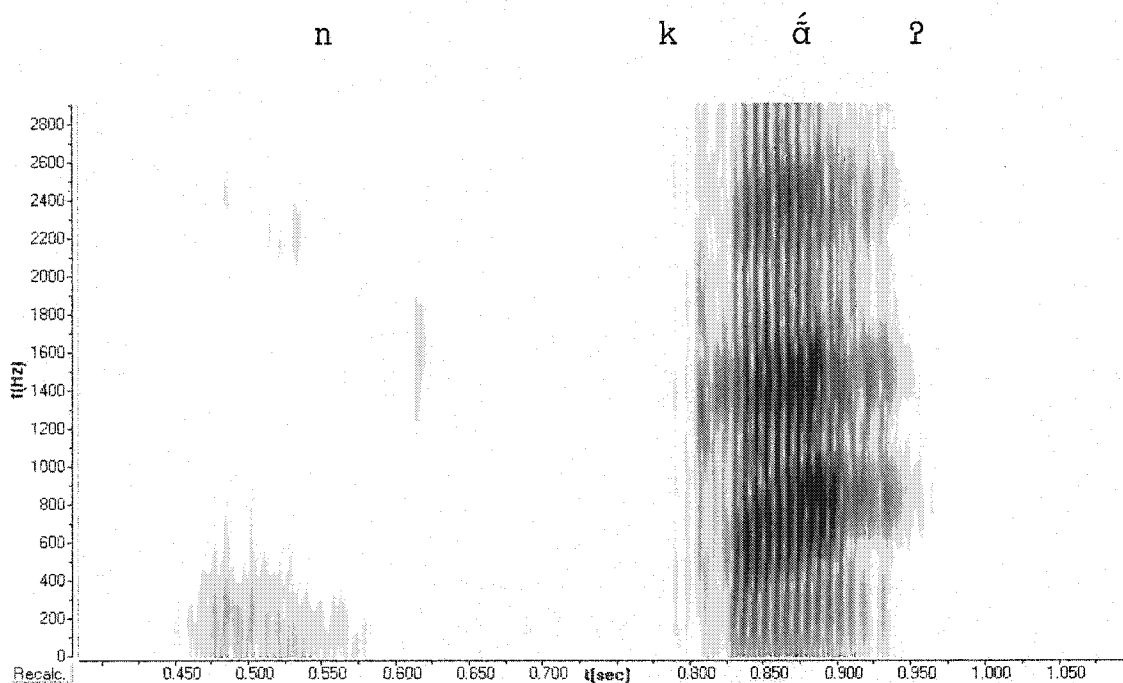

Figure 3-3 Voiceless velar stop in 'crow'.

k^h ú p

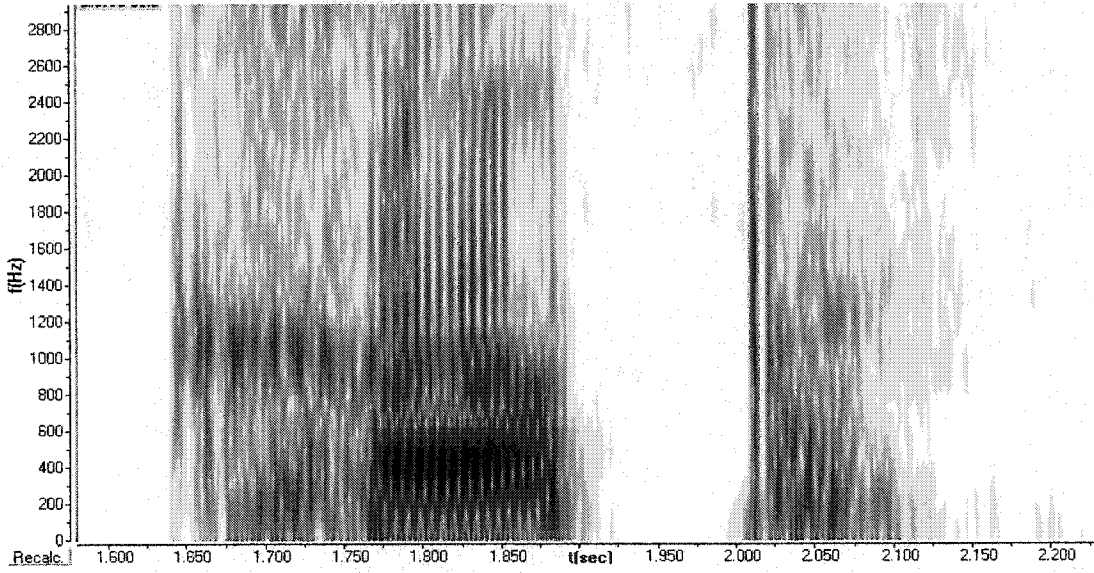

Figure 3-4 Aspirated velar stop in 'they reject him'

n k' é ʃ

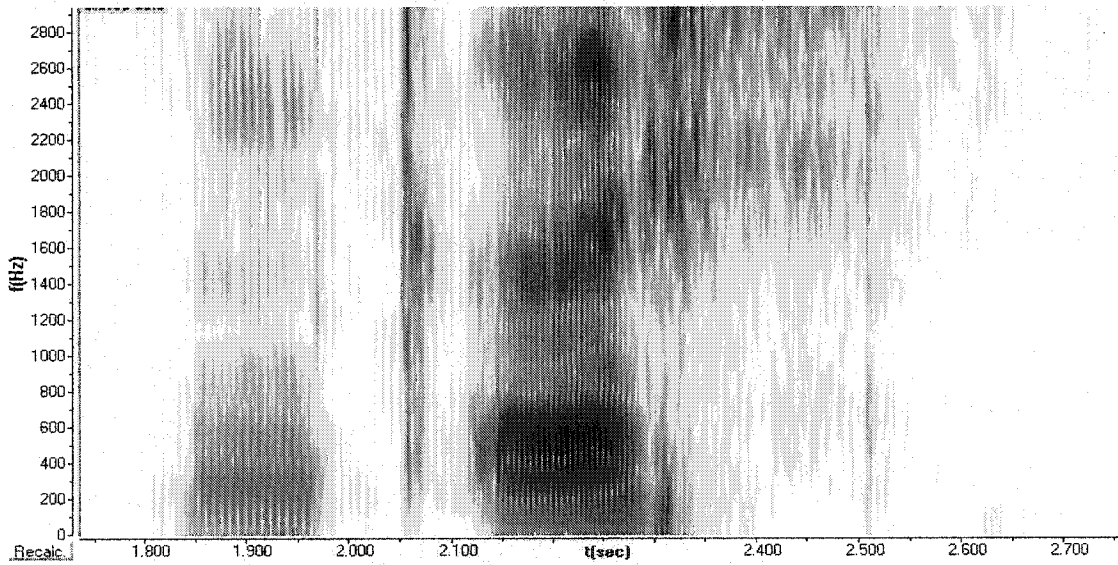

Figure 3-5 Glottalized velar stop in 'piece of paper'

This is represented on the spectrogram by two complete cessations of airflow and formant structure with an intervening burst. Looking at the glottalized velar stop in figure 3-5, the first is that of the tongue back retracting from its place of articulation (i.e. the velum) and the second release is that of the vocal folds and subsequent return to normal pulmonic airflow for the following vowel. The combination of an oral release followed by a glottal release might suggest that these are two separate segments (i.e. an oral stop followed by a glottal stop). However, the distribution of glottalized segments in the phonology of Northern Pame unequivocally supports their status as a unit phoneme rather than a sequence of a consonant plus a glottal stop (see chapter 4).

3.2.3. *Fricatives*

Northern Pame oral fricatives are only contrastive for place of articulation.

(3) /s/ ~ /ʃ/

ALVEOLAR		POST-ALVEOLAR	
nt'és	'grasshopper'	nk'éʃ	'piece of paper'
sú	'he complains'	ʃáwʔ	'it is over'

3.2.4. *Nasals*

Plain nasals contrast with their aspirated and glottalized counterparts. Voiced nasal consonants are produced with an oral occlusion, identical to an oral stop; however, the addition of a lowered velum allows air that would be otherwise trapped in the oral cavity to escape through the nasal cavity and out the nostrils.

(4) /m/~m^h/~m' /, /n/~n^h/~n' /, /ɲ/~ɲ^h/~ɲ' /

PLAIN		ASPIRATED		Glottalized	
/mɑ̃n/	'he wants'	/m ^h ʝɛ̃n/	'soup	/nm'ú/	'cactus'
/nmæ̃ʔp/	'donkey'	/dɛ̃ʔm ^h ɛ̃/	'they had'	/nm'æ/	'bed'
/næ̃hæp/	'he runs'	/n ^h ɛ̃ʝʔ/	'he enters'	/nn'uk/	'my lice'
/ɲuæ̃/	'guns'	/nʔɲ ^h æ̃/	'word'	/ɲ'új/	[ɲ ^{d̥} új] 'old' ²¹

Figure 3-6 is a spectrogram of a voiced nasal consonant, which has the acoustic characteristics of 1) identifiable formant structures, 2) periodic vocal fold vibration indicating voice, and 3) a washing out of spectral intensity, due to the canceling out of resonances with anti-resonances.

²¹ The glottalized palatal nasal is an abstract segment, which in fact never surfaces. What does surface is [d̥] only with a palatal nasal consonant as in the example for 'old'. The explanation given in 7 is one of glottal buccalization where a glottal stop, or a glottal release for a sonorant at times must buccalized (receive oral place features). This is always the case with glottalized nasals, for example, during palatalization. Hence, a glottalized palatal nasal is incompatible to the phonology of the language.

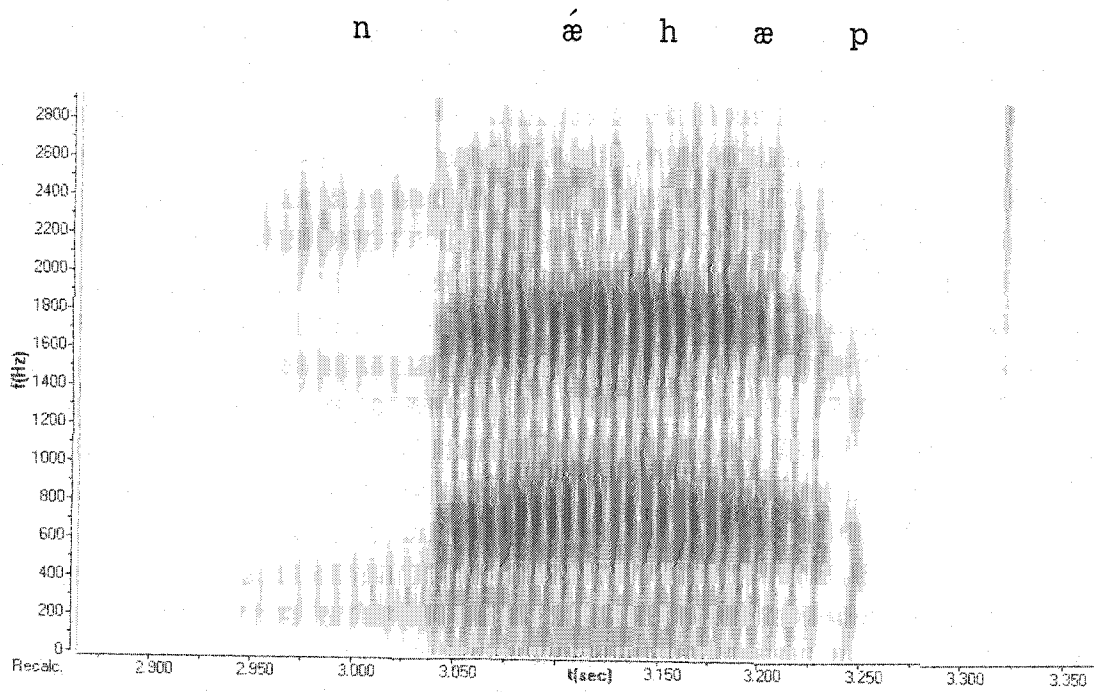

Figure 3-6 Plain alveolar nasal in 'he runs'

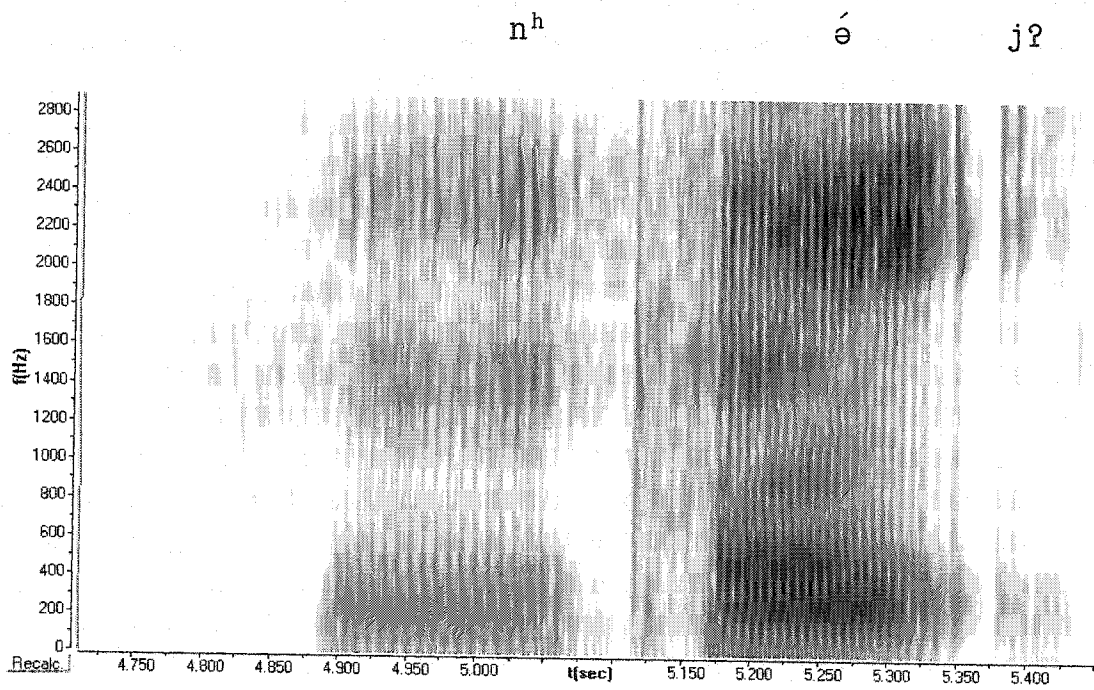

Figure 3-7 Post-aspirated alveolar nasal in 'he enters'

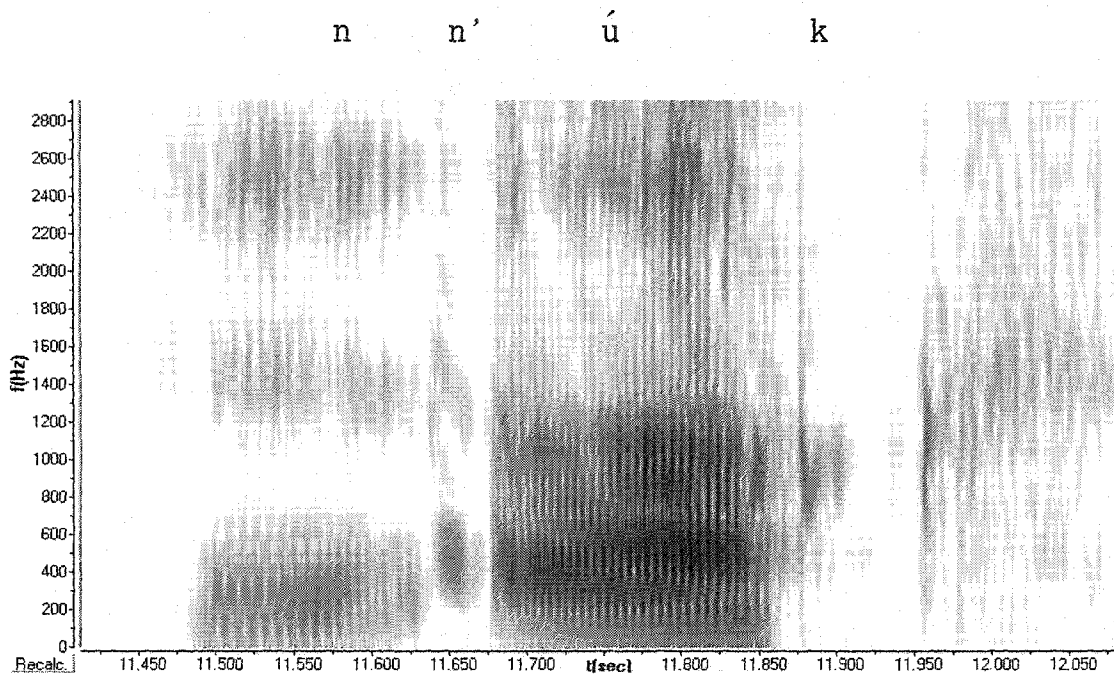

Figure 3-8 Post-glottalized alveolar nasal in 'my lice'

When an oral vowel follows a nasal consonant, the increase in spectral intensity can be clearly seen as in figure 3-6, where the velum is now raised and anti-resonances cease to exist. A defining characteristic of Northern Pame laryngeally complex nasals is that the laryngeal gesture occurs at the nasal release, not the closure. The post-aspiration illustrated in figure 3-7 shows a nasal consonant followed by approximately 50 milliseconds of frication before voicing initiation of the following vowel. This contrasts sharply with the absence of frication for the voiced nasal figure 3-6. In the case of the post-glottalized nasal, figure 3-8 shows a nasal consonant where vocal fold vibration reduces to zero for approximately 60 milliseconds followed by glottal release and immediate vocalic voicing.

3.2.5. Flaps

The alveolar flap is in contrast with the palatalized flap and voiced alveolar stop.

(5) /r/~ /rʲ/~ /d/

PLAIN FLAP	PALATALIZED FLAP	VOICED ALVEOLAR STOP
/rəsáwt/ 'shades'	/rʲát/ 'enough'	/dəsáwʔ/ 'he measured'
/lərəwʔ/ 'I am thirsty'	/ʃkirʲún/ 'conqueror'	/gədəw/ 'youth'

The spectrogram below is an example of a Northern Pame alveolar flap.

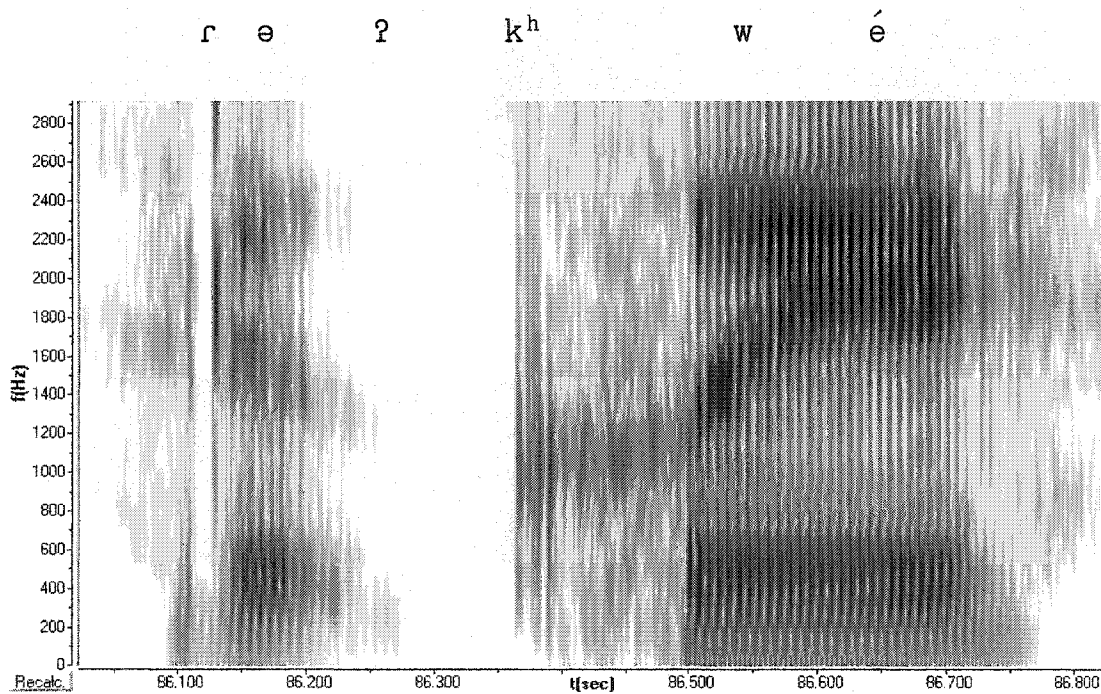

Figure 3-9 Alveolar flap in 'my bloods'

The alveolar flap represented in figure 3-9 can be identified by two indicators: 1)

complete oral occlusion with subsequent zero formant structure during occlusion, and 2) sustained voicing. The flap as defined by Catford (1988:72) is a momentary sound with an oral tract occlusion that is equivalent to a passing touch, whereas obstruents are characteristically longer in duration with the articulator (i.e. tongue blade in this case) maintained in a constricted position. Acoustically speaking, flaps are very similar to voiced alveolar stops, just shorter in duration.

3.2.6. Laterals

Laterals contrast for alveolar and post-alveolar place of articulation in addition to the laryngeal settings of aspiration and glottalized.

(6) /l/ ~ /l' / ~ /l^h /

PLAIN	GLOTTALIZED	ASPIRATED
/ləʃáwʔ/ 'he learns'	/l'æ/ 'person, man'	/ləʔl ^h úʔ/ 'he is calm'
/nʔlús/ 'my cross'	/l'átʃ/ 'they kick'	/l ^h ún/ 'they care'

(7) /ʎ/ ~ /ʎ' / ~ /ʎ^h /

PLAIN	GLOTTALIZED	ASPIRATED
/ʎúnk/ 'my chicken'	/ʎ'ædet/ 'persons, men'	/ʎ ^h æʔ/ 'buttocks'
/niʎús/ 'your cross'	/təʎ'áhaw/ 'they speak'	/ʃiʎ ^h á/ 'dish'

Let us consider these contrasts with the following spectrograms.

l e ſ a w?

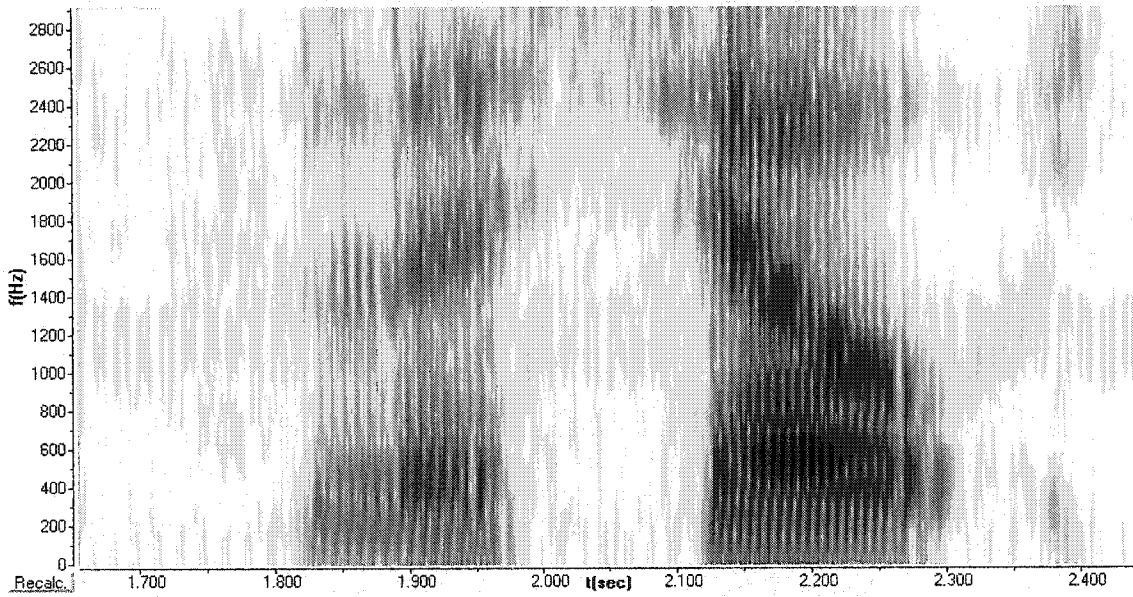

Figure 3-10 Plain lateral in 'he learns'

l' [l²l] æ

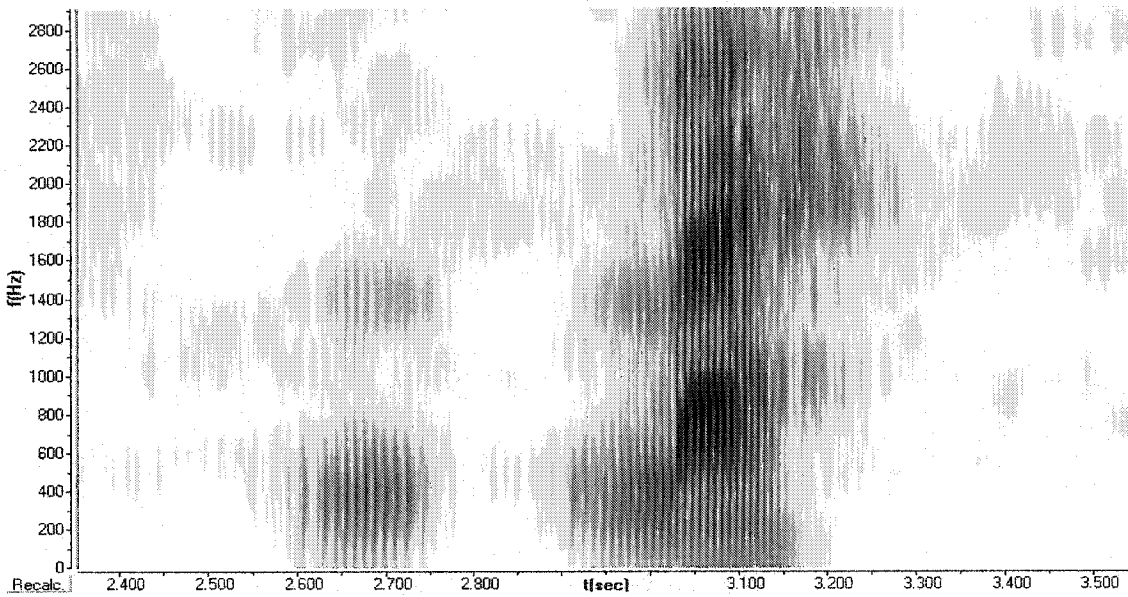

Figure 3-11 Glottalized lateral in 'human, man'

l^h[l^hl] ú n

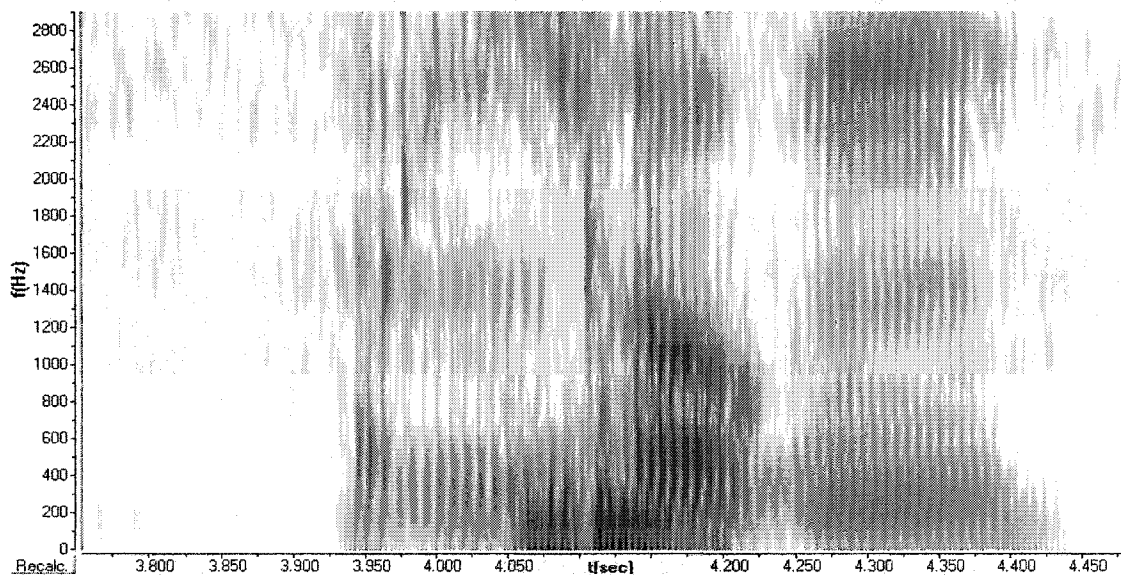

Figure 3-12 Aspirated lateral in 'they care'

Laterals, like their nasal counterparts contrast for aspiration and glottalization. However, unlike nasals the laryngeal gestures for laterals are not necessarily relegated to the release, but may occur either throughout the segment, with the highest degree of laryngeal abduction or constriction occurring in the middle, or optionally on the lateral release. For example, the glottalized lateral in figure 3-11 begins in modal voice, with vocal fold vibration slowing down to zero in the middle of the segment and then resuming into modal voicing again. A similar situation occurs with the aspirated lateral in figure 3-12, although voice cessation need not occur during laryngeal abduction as it indeed does in glottalization.

3.2.7. Glides and laryngeals

The glides contrast for labio-velar versus palatal and the laryngeals for continuancy.

(8) /j/~w/, /h~/ʔ/

PALATAL GLIDE

/jǔgət/ 'give it to me'

/ʃiʔjǔj/ 'Pame'

LARYNGEAL FRICATIVE

/bəhǎw/ 'good pl.'

/hwéw/ 'it cures'

LABIO-VELAR GLIDE

/wá / 'still'

/mawíʔi/ 'his knee'

GLOTTAL STOP

/bəʔáw/ 'tasty pl.'

/ʔwátʃ/ 'he kicks'

3.3. Vowels

Northern Pame has the following vowel quality inventory.

TABLE 3-2. Northern Pame vowels

	FRONT	CENTRAL	BACK
High	/i/		/u/
Mid	/e/	/ə/	
Low	/æ/		/ɑ/

There are six basic vowel qualities in Northern Pame. The two high vowels are produced with a raised dorsal articulator. There is only one vowel that has lip rounding, /u/. There are two low vowels and one mid-front vowel. It should be noted that the central vowel (schwa) freely varies from mid to high. There has been some ambiguity as to whether or not Northern Pame has phonemic /o/ as does Central Pame (Avelino 1997: 43, 66).²² Elicited data have shown some contrast with /u/ admittedly, but likewise, speakers seem unwilling to hear a contrast between /o/ and /ɔw/. Likewise, there is some Northern Pame dialectal variability between this latter pair (speakers from Agua Puerca prefer the vowel-glide sequence while those from Cuesta Blanca prefer the single vowel). These facts compel us to maintain a more parsimonious approach of a vowel-glide cluster rather than a new phoneme /o/. Contrasts for vowel quality are given below.

(9) Vowel quality

a. /i/~ /e/

/mat̪s̪i/ 'cup'

/dɛt̪séʔ/ 'he took it'

/mpí/ 'fat'

/mpé/ 'brush'

b. /e/~ /æ/

/guts̪h'éʔ/ 'snake'

/np̪h'æʔæʔ/ 'mat'

²² See Chapter 2. Central Pame has this same distinction but with the /o/ phoneme rather than /u/. This is a consistent phonological correspondence between the two languages.

	/t̂s' éʔ/	'they take it'	/kəntá/	'water'
c.	/u/~/ə/			
	/ntún/	'flower'	/gutén/	'mountain lion'
d.	/e/~/ə/			
	/dət̂séʔ/	'he took it'	/dət̂sé/	'plumb'
	/n' t̂ʃ' ě/	'they are about to make'	/ʃt̂ʃ' éʔ/	'tortilla plate'
e.	/ɑ/~/æ/			
	/kətá/	'water hole'	/kəntá/	'water'
	/t̂ʃáʔ/	'clearings'	/kət̂ʃæ/	'your water'

3.3.1. Nasal Vowels

There are six nasal vowels that correlate with the oral vowel qualities described above.²³ The contrasts for nasal vowels are given below.

(10) Oral/nasal contrasts

ORAL		NASAL	
/níp/	'no'	/sín/	'he opens'
/gulě́n/	'he left'	/nʔě́/	'you are about to make'

²³ High-front nasal vowels are ambiguous regarding their phonemic status. They clearly surface as allophones before a nasal consonant. When no nasal follows, high-front vowels freely vary with /ē/. This is complicated by the fact that /e/ is contrastively oral or nasal when followed by a nasal consonant coda.

/basǎ/	'com.pl.'	/basǎ/	'itch'
/nt'ŭs/	'house'	/nʔt ^h ŭs/	'my salt'
/nts'éʔ/	'jug'	/ntʃǒp/	'river'
/nt ^h ǎʔæ/	'influenza'	/nt ^h ǎʔæ/	'tamale'

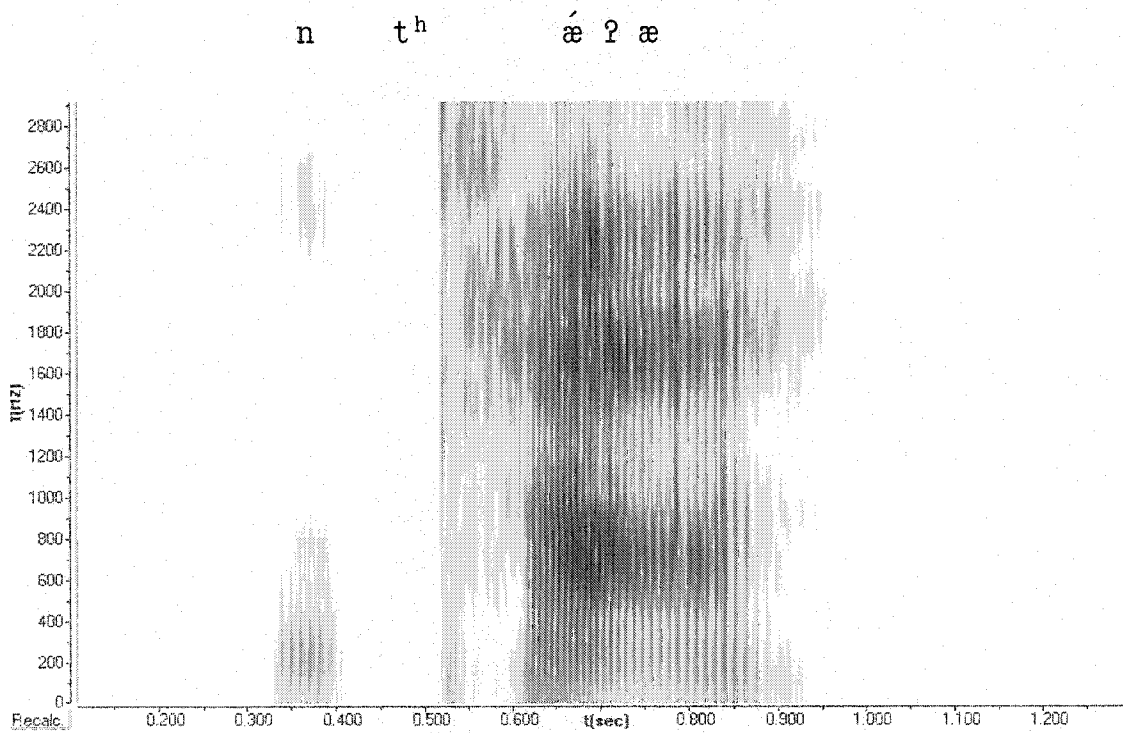

FIGURE 3-13. Spectrogram of an oral vowel in 'influenza'

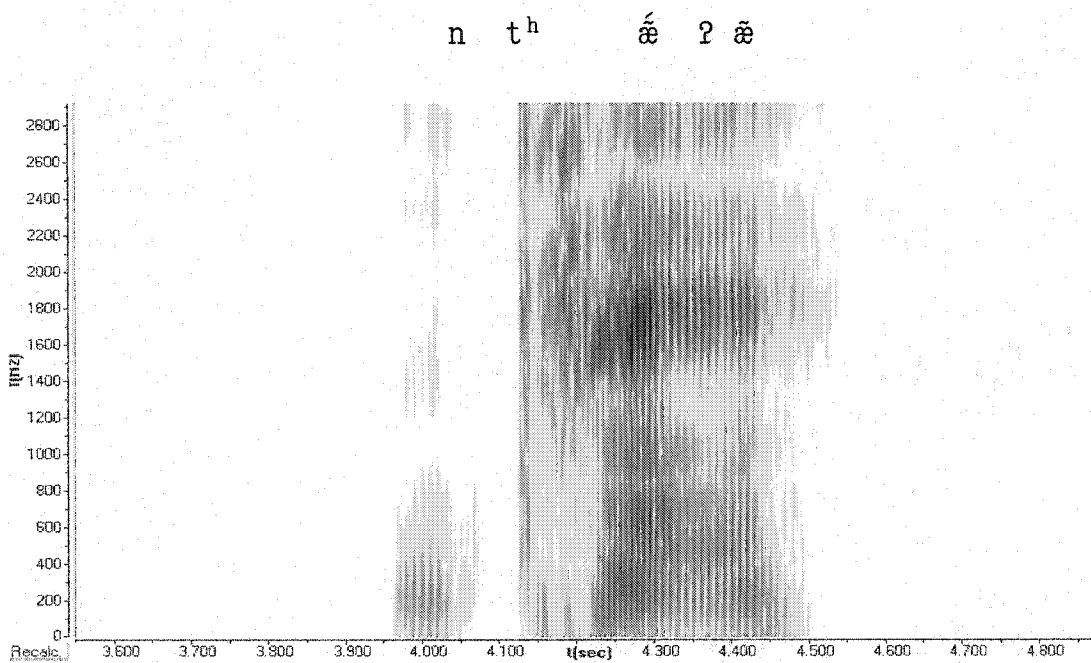

FIGURE 3-14. Spectrogram of a nasal vowel in 'tamale'

The defining characteristic of a nasal vowel is nasal resonance from velum lowering, so that egressive airflow can pass through the nasal cavity and out the nostrils (Anderson 1975, Crothers 1975). Because of the dispersed airflow, anti-resonances occur in the nasal cavity that cancel out those of the oral cavity resulting in a decrease of acoustic energy particularly with the F1 vowel formant. This dampening effect of the vowel tends to decrease the perceptibility of nasalized vowel place versus oral vowel. Thus, languages with contrastive nasalization will have either the same number of nasal and oral vowels, or fewer nasalized vowels than oral ones.

The spectrograms in figures 3-13 and 3-14 exemplify the acoustic contrast of a higher degree of formant structure for an oral vowel versus a washing out and greater bandwidth of

F1 for a nasal vowel.

3.4. Tone

Northern Pame has two contrastive tones, which are a high tone and a rising tone.

Tone is contrastive on the lexical root, which is also the location of stress.

TABLE 3-3. Northern Pame tones

HIGH TONE / \acute{v} /

RISING TONE / \check{v} /

Thus, identical to other Pame descriptions (Avelino 1997, 2002, Gibson and Bartholomew 1979, Gibson 1956 and Manrique 1967) this dissertation describes tone as fundamentally a pitch-accent system.

There are a number of factors that should be kept in mind with Northern Pame tone. First, as mentioned previously tone is only contrastive on the lexical (and stressed) root, which with one exception, is always monosyllabic. Pitch variations on non-root syllables can always be determined by the pitch of the root syllable. Second, a rising tone is phonetically realized by a low to high rising pitch, which causes rightward compensatory lengthening on a single root syllable. That is, compensatory lengthening of a rising tone occurs only when no syllables follow the lexical root. Consider the grammatical tone contrasts in (11).

(11) Tone on stressed syllables only.

HIGH		RISING	
/nipás/[nipás]	'your orange'	/nʔnǎs/[nʔnǎ:s]	'my orange'
/nʔkwás/[nʔkwás]	'my cow'	/netʃǎs/[netʃǎ:s]	'your cow'
/nʔt ^h úʔ/[nʔt ^h úʔ]	'my armadillo'	/ntʃ ^h ǔʔ/[ntʃ ^h ǔ:ʔ]	'your armadillo'
/n ^h tʂéʔ/[n ^h tʂéʔ]	'my bean pot'	/n ^h tʂěʔ/[n ^h tʂě:ʔ]	'your bean pot'

These tone contrasts are represented in phonemic and phonetic form. Notice that the high tone forms have no compensatory lengthening in the phonetic manifestation, while the rising tone must have it.

Figure 3-15 'your orange' contains a high tone where the vowel duration is approximately 200 milliseconds with a rapidly rising pitch frequency plateauing at 170 Hz at the syllable peak. The rising tone in figure 3-16 'his orange' has a vowel length of nearly 380 milliseconds with a pitch frequency that gradually ascends from 110 Hz to 170 Hz towards the end of the nucleus. Apart from the change in pitch, however, a rising tone can potentially lengthen a syllable to nearly twice the duration of a high tone.

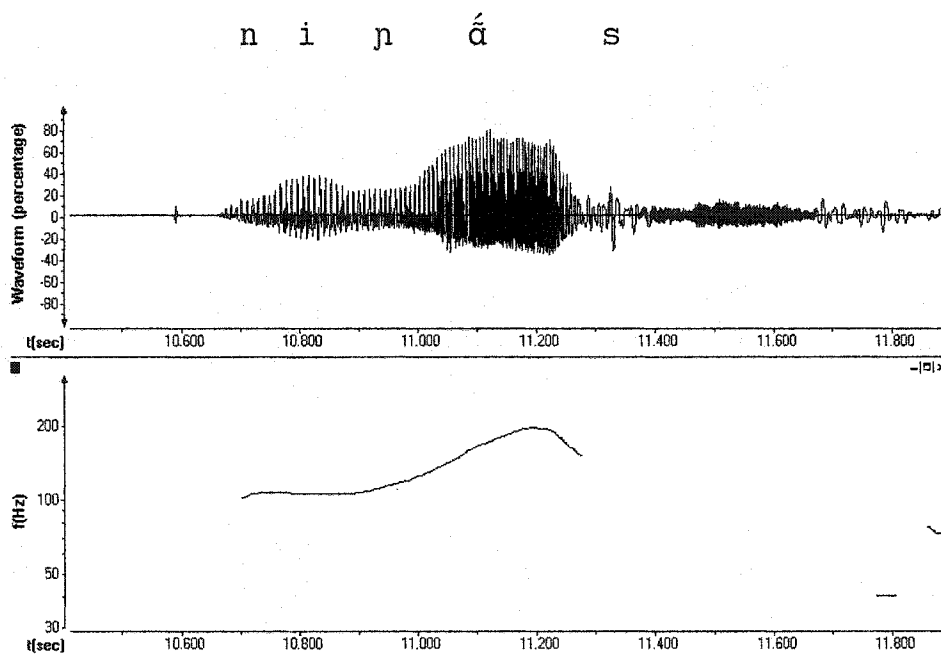

FIGURE 3-15. Waveform and pitch track for a high tone on 'your orange'.

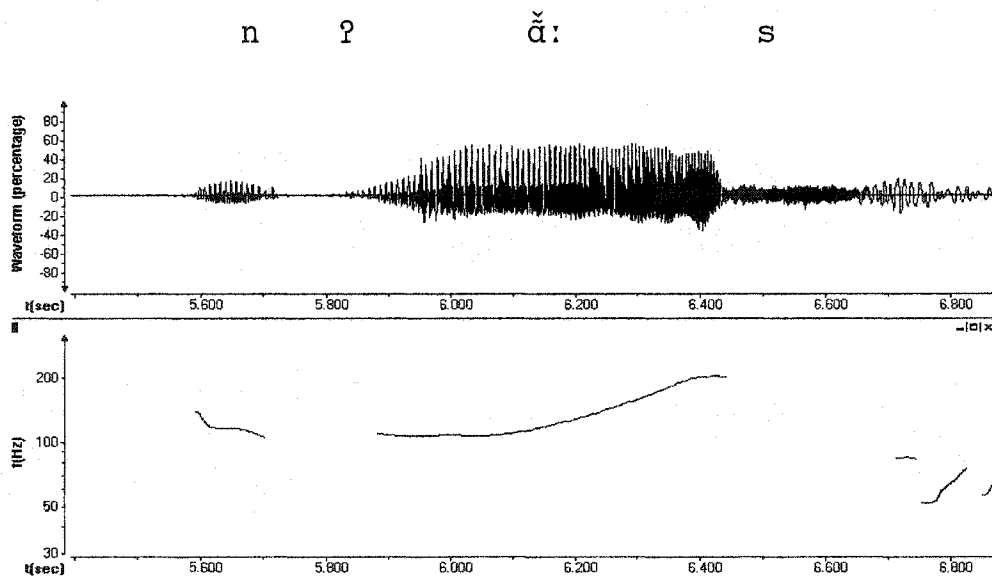

FIGURE 3-16. Waveform and pitch track for a low (rising) tone in 'my orange'.

There are two scenarios where compensatory lengthening will not take place: if a root or stem is polysyllabic, or if a sonorant is contained in the coda of a stressed syllable. In these cases, the rising tone will spread from the stressed syllable being the lowest pitch to the most rightward syllable being the highest pitch. A high tone will be followed by an allophonic low pitch on the post-stressed syllables. This pattern is illustrated in (12). These examples each contain at least one additional syllable to the right of the root. In these cases, a rising tone will not cause compensatory lengthening.

(12) Rising tone spread from stressed syllable rightward.

HIGH		RISING	
/n ^h púhu/ [n ^h púhù]	'my chair'	/n ^h pǔhu/ [n ^h púhú]	'your chair'
/nʔnæʔæp/ [nʔnæʔæp]	'his liver'	/ni.nǎʔæp/ [ni.næʔæp]	'your liver'
/ntʃ'án/ [ntʃ'áwǵǵ]	'your avocado'	/ntʃs'áwn/ [ntʃs'áwǵǵ]	'avocado'
/má/ [má]	'he goes'	/tamǎje/ [tamǎjé]	'we.Dl shout' ²⁴

Further evidence for this process is represented in the waveforms for 'chair' in 3-17 and 3-18. These figures are waveforms for a root with a laryngeally ambiguous vowel of the form VhV. These types of roots are interpreted as a sequence of vowel-laryngeal-vowel segments which make up two syllables. Because there is more than one syllable available, a rising tone already has the minimum tone bearing units needed and therefore, no vowel

²⁴ from *amǎ* 'he shouts'

lengthening takes place.

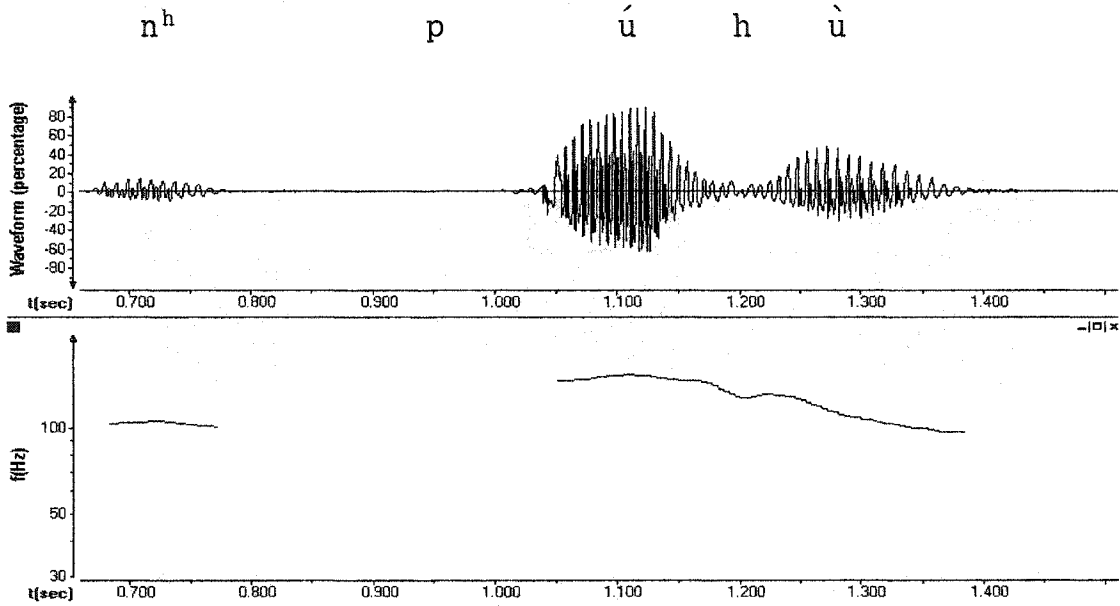

FIGURE 3-17. Waveform and pitch contour for 'my chair'.

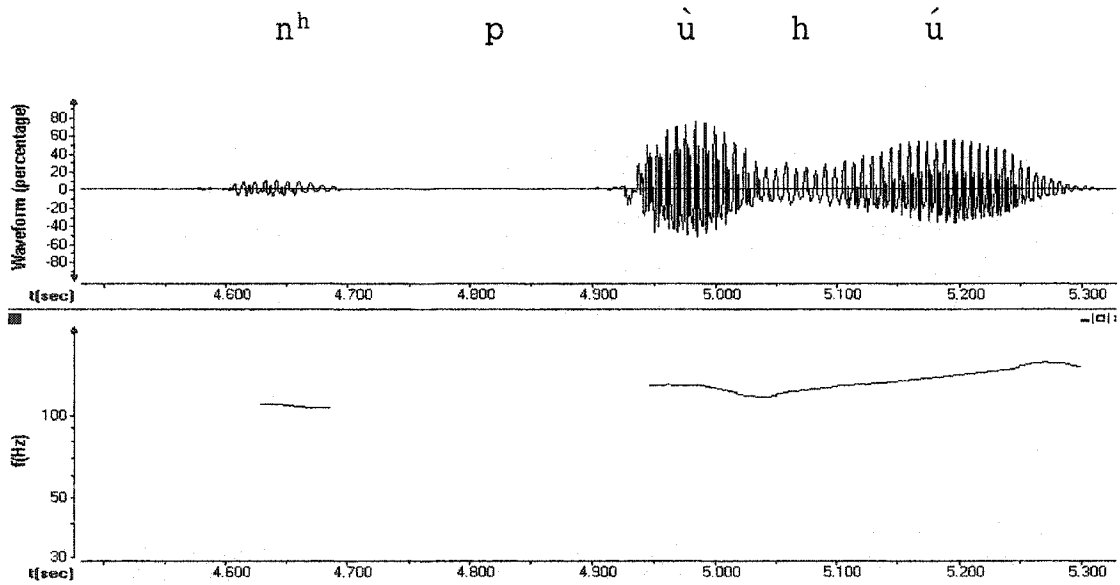

FIGURE 3-18. Waveform and pitch contour for 'your chair'.

In summary, Northern Pame tones must be either high or rising and are contrastive only on the stressed syllable. It is worth mentioning that a vowel length interpretation will account for the data in (11) as well as a tonal one. However, the data in (12) can be only explained by appealing to the tone of the stressed syllable since no lengthening exists. Consequently, vowel length must be taken as a purely allophonic process.

3.5. Conclusion

Northern Pame consonants can be segmentally complex with the greatest complexity of contrast found among the stop consonants contrasting for voicing, aspiration and glottalization. Although the presence of all these gestures makes Northern Pame quite marked in its inventory, the fact that the laryngeal features occur at the stop-vowel transient is expected. The setting of laryngeal contrast at the release of a stop is an acoustically and perceptually optimal place for maintaining phonemic distinction (Silverman 1995). More marked, however, are the nasal consonants, which also contrast for laryngeal gestures on their release.

The vowels, which are distinctive for six qualities, can also be contrastively nasal. Finally, Northern Pame tone (high or rising) is contrastive on the lexical root and will spread rightward if a sonorant or additional syllable is available.

CHAPTER 4

SEGMENTATION

4.1. Introduction

Northern Pame consonants and vowels both contain patterns that can be interpreted as either a sequence of two segments or a unit of a complex segment. With regard to consonants, ambiguous sequences include such things as a consonant followed by a glide /w/, /j/, laryngeal /h/, /ʔ/ or in some cases both.

Table 4-1. Complete unit approach to Northern Pame consonants.

	VOICELESS			ASPIRATED			GLOTTALIZED			VOICED				
	PLN	PAL	LAB	PLN	PAL	LAB	PLN	PAL	LAB	PLN	PAL	LAB		
BILABIAL STOPS	/p/	/p ^j /		/p ^h /	/p ^h ^j /							/b/	/b ^j /	
CORONAL STOPS	/t/			/t ^h /			/t'/					/d/		
APICAL AFFRICATES	/t̪s/			/t̪s ^h /			/t̪s'/							
POST-ALVEOLAR AFFRICATES		/t̪ʃ/			/t̪ʃ ^h /			/t̪ʃ'/						
DORSAL STOPS	/k/		/k ^w /	/k ^h /		/k ^{hw} /	/k'/		/k' ^w /	/g/		/g ^w /		
FRICATIVES	/s/	/ʃ/												
BILABIAL NASALS				/m ^h /	/m ^h ^j /		/m'/	/m' ^j /				/m/	/m ^j /	
CORONAL NASALS				/n ^h /	/n ^h ^j /		/n'/	/n' ^j /				/n/	/n ^j /	
LATERALS	/l/	/l̪/		/l ^h /	/l̪ ^h /		/l'/	/l̪'/						
FLAPS												/r/	/r ^j /	
GLIDES													/j/	/w/
LARYNGEAL FRICATIVE				/h/	/h ^j /	/h ^w /								
GLOTTAL STOP							/ʔ/	/ʔ ^j /	/ʔ ^w /					

Table 4-1 illustrates an unrestricted unit approach to Northern Pame consonants. Under this approach, one would posit 53 consonants.

Northern Pame vowels offer similar challenges where sequences such as V?V and VhV have been interpreted as units in some other Otomanguean languages, while sequences in still others (Silverman 1997a, 1997b, Silverman, et al. 1995). If the unit approach is taken in Northern Pame, the vowel inventory would contain 36 possible vowel phonemes.

TABLE 4-2. Complete unit approach to Northern Pame vowels.

	FRONT		CENTRAL	BACK	
HIGH	/iᵛiᵛ/	/īᵛīᵛ/		/uᵛuᵛ/	/ūᵛūᵛ/
MID	/eᵛeᵛ/	/ēᵛēᵛ/	/eᵛeᵛ/	/ēᵛēᵛ/	
LOW	/æᵛæᵛ/	/ǣᵛǣᵛ/		/ɑᵛɑᵛ/	/āᵛāᵛ/

The problem should be clear with regard to Northern Pame segmentation: for such an inflated segmental inventory to exist with 88 phonemes, there would have to be considerable phonological support from the distribution of segments. Are such data available and what kind of segmentation do they support?

This chapter investigates the specific segments involved for both consonant and vowels in Northern Pame. In addition, previous analyses are considered for Pamean

languages in light of the data facts in Northern Pame. Finally, a reanalysis is given for each suggesting a unit approach for consonants, with exception being taken with the classes of bilabial (palatalized), laryngeals (palatalized and labialized) and velars (labialized). Likewise, a sequence approach is claimed with regard to what are termed here “laryngeally ambiguous vowels”.

4.2. Segmentation of consonants

The segmentation of Northern Pame consonants poses a challenge to traditional procedures, due to its high number of ambiguous sequences on the one hand, and its dearth of unambiguous examples on the other. There are two reasons for this ambiguity. First, the distribution of ambiguous sequences is limited, with a few exceptions, to the onset position of the lexical root. Therefore, taking the strategy of looking for similar ambiguous sequences in other positions such as the onsets of affixes or the coda position is problematic. A second related problem is that the onset position of the lexical root is the location of morphological consonant coalescence. Thus, many of the ambiguous sequences found in this position are most often morphologically complex, which makes assigning form to function a very difficult task.

The limited position of consonantal contrasts coupled with morphological skewing in the same position has resulted in the interpretation that there are two types of segmental contrasts; lexical versus morphological (Avelino 1997). For example, /tʃ/ is listed as a morphological contrast (80) by virtue of the fact that it commonly occurs at the onset of a lexical root, which is usually subject to prefixation. Contra to Avelino’s approach is research in this dissertation based on additional data that support a claim that all morphological

contrasts are indeed lexical. Although a high amount of these complex segments occur at a morpheme boundary, it is not always the case as /ʃtʃ'éʔ/ 'tortilla plate', a monomorphemic word illustrates. Therefore, the question of segmentation is recast in this dissertation whereby suggesting that such data be interpreted as complex lexical (only) segments, such as aspirated, glottalized, palatalized, with a residual group that are interpreted as consonant clusters.

4.2.1. *Complex segments versus complex sequences*

The segmentation of phonemes is a fundamental procedure in ascertaining contrastiveness in a phonological system. In order to account for what constitutes a segment, we look for a number of patterns. First, contrastive simple segments are included in the consonantal inventory and are used as a comparison with ambiguous sequences of sounds, which can potentially be: 1) a sequence of two or more phonemes (i.e. /p^h tʃ b^m/) or 2) a complex segment (i.e. /p^h tʃ b^m/).

There are several principles to determine segmentation, which include economy, phonotactic homogeneity of syllable constituents, or segmental distribution throughout a phonological word. If there are relatively few ambiguous sequences, and the language prefers simple phonotactics, then a unit approach is preferable since it preserves the syllable patterns while minimally increasing the segmental inventory. On the other hand, if syllable complexity is allowable as exemplified in non-ambiguous sequences, then it is best to segment ambiguous segments as sequences also (Burquest and Payne 1993: 114-116). Another clue to look for in segmenting ambiguous sequences is their distribution throughout

a word. If it can be shown that a sequence is found in several different syllable positions, then there is evidence that it is functioning as a single segment.

4.2.1.1. *The problem of consonantal ambiguity*

Northern Pame consonantal segmentation is complicated by the fact that although there are many ambiguous sequences, data of unambiguous sequences are hard to come by. The result is an apparent even trade off where a sequence approach will increase syllable complexity, while a unit approach will increase the complexity of the segmental inventory as illustrated in tables 4-1 and 4-2.

As a means of keeping the phonemic inventory as small as possible, early Pameanists such as Gibson (1956) and Manrique (1967) unilaterally opted for the sequence approach to segmenting phonemes. However, the sequence approach has the dire effect of complicating the syllable structure of the language. We can see this in the comparison of the same data from both approaches in (1).

(1) Sequence and unit approach and syllable complexity.

SEQUENCE APPROACH		SINGLE UNIT APPROACH		
CCCVC	/nthúʔ/	CCVC	/nt ^h úʔ/	'armadillo'
CCCV	/nmʔæ/	CCV	/nm'æ/	'bed'
CVCCCV	/nəʔpjǎ/	CVCCV	/nəʔp ^j ǎ/	'you completed'
CVCCVCV	/təʔhǔʔu/	CVCCV	/təʔhǔ/	'I am able'

The sequence approach allows for consonant clusters up to CCC in these sample data, while the single unit approach has a maximum onset CC. Thus, from a syllabic economy perspective, allowing for complex segments should be considered.

Avelino (1997) takes the other extreme in viewing all ambiguous sequences as complex segments, but limiting the productivity of many of these segments to the morphological realm. This approach lacks in showing a clear motivation of the language to indeed limit certain phonemes to lexical or morphological environments. The language facts indeed show that complex segments can and do appear in monomorphemic words and in environments other than the onset of the lexical root. Therefore, more allowance must be made for the lexical status of these segments.

4.2.1.2. *Consonant coalescence and lexical contrast*

A second complexity that has consequences for consonantal segmentation is that of Northern Pame consonantal coalescence, which occurs at the juncture between the initial consonant of a lexical root and an affix. Coalescence at this location allows for a great variety of ambiguous consonant sequences to be derived. For example, looking at a Northern Pame transitive verb paradigm, we see that a palatal or labio-velar glide makes up part of the prefix to mark subject person.

(2) Verb (L-D) paradigm.

SUBJECT	INCOMPLETEIVE	COMPLETIVE
1 st	/lə-/	/nəw-/
2 nd	/k'əj-/	/nəj-/
3 rd	/w-/	/dəw-/

Prefixes such as these pose difficulties in the Northern Pame segmentation because Northern Pame glides are prohibited from being in complex syllable codas, with a few exceptions not relevant here. The outcome is that the glide will either coalesce with the following (root initial) consonant, if they share the same place of articulation. If they do not, they will either metathesize or in the case of /w/, it will delete. Thus, applying the prefixes in (2) will derive the forms in (3), where the /s/ in /sáwʔ/ coalesces with the glide of the prefix for second person subject.

(3) Paradigm for /sáwʔ/ 'teach'.

SUBJECT	INCOMPLETEIVE	COMPLETIVE
1 st	ləsáwʔ	nəsáwʔ
2 nd	k'əʃáwʔ	nəʃáwʔ
3 rd	sáwʔ	dəsáwʔ

Here, the palatal glide is completely lost due to consonant coalescence (see chapter 8). The result is a post-alveolar fricative, a morphophonological alternate to the lexical alveolar fricative. In addition, notice that the labio-velar glide is simply deleted from the surface forms in (3). Focusing on the coalescence of /j/ and /s/, we see that the alveolar fricative is the new surface form produced by a morphological concatenation. In this case, the resultant segment is crucially a lexical contrastive segment, a fact well attested in data such as the following.

- (4) Contrast of /s/ and /ʃ/
 nt'és 'grasshopper'
 nk'éʃ 'piece of paper'

Another example of morphophonemic complexity can be seen with the difference between lexical aspiration and grammatical aspiration.

- (5) Lexical versus morphological segments.

	UNDERLYING FORM	SURFACE FORM	
a.	[n[k ^h wǎ]]	[nk ^h wǎ]	'rabbit'
b.	[w ^h [kǎn]]	[k ^h wǎn]	'they dragged'

In the example in (5), we have the same surface structure consisting of [k^hw] in both (a) and (b), but their underlying forms are quite different.

The words ‘rabbit’ and ‘they dragged’ are compared for aspiration and /w/ , but where these two processes are purely lexical in (5a), they are purely morphological in (5b). In the case of ‘rabbit’, aspiration and /w/ have no morphological status whatsoever, but are part of the root. In comparison, ‘they dragged’ has the 3rd person morpheme /w/ as well as aspiration indicating plural subject. Both words are phonetically the same regarding these gestures, but distinct in their underlying morphological structure.

As the above examples demonstrate, Northern Pame lexical segments and morphophonemic processes have considerable overlap and make it difficult to determine what represents a phonemic segment and what does not.

4.2.2. *Previous approach to segmentation (Avelino 1997).*

Avelino (1997) is the first linguist to address the issue of Northern Pame consonantal segmentation in a systematic way. He mentions that in all previous analyses of Pamean language, specifically Jiliapan Pame (Manrique 1967) and Central Pame (Gibson 1956) a sequence approach was used as a default method. Avelino, however, takes a unit approach assuming a larger consonantal inventory, while accounting for the process of coalescence. He remarks that the difference in his (unit) approach compared to those the previous scholars is solely based ‘on the model adopted by each researcher and not on the “language.”’ His point is that any approach must be theoretically driven, whether it is a sequence or a unit approach.

The theoretical model Avelino adopts is one of *contrastive oppositions* as described

by Trubetzkoy in *Principles of Phonology* (1939). Under such a model, Avelino makes a number of assumptions. First, he considers consonantal mutation, rather than infixation, to be the productive morphological process on lexical root consonants (130, footnote 43). His claim in this regard is that while mutation of consonants in Otomanguean languages is well attested, infixation is not (111). Second, Avelino asserts that there are two levels of consonantal contrasts to be considered; lexical and morphological. He says,

...en este trabajo he decidido que las oposiciones que hasta el momento he registrado exclusivamente con función morfofonológica no serán tomadas como diagnóstico determinante para postular unidades fonológicas, la lógica del razonamiento es que todo contraste fonémico, i.e. el que se encuentra entre lexemas distintos, puede estar accesible también al nivel morfofonológico, pero no necesariamente todo contraste morfofonológico debe ser fonológico (80).

...in this work I have decided that the oppositions which up to now I have exclusively listed with a morphophonological function will not be taken as a determining diagnostic to postulate phonological units, the logic of reasoning is that all phonemic contrast (i.e. what is found in lexical distinctions) can also be accessible at the morphophonological level, but not necessarily must all morphophonological contrasts be phonological.

That is to say, in order to deal with the question of what is a lexical property of a segment, Avelino proposes that there can be morphologically contrastive segments that are not necessarily contrastive phonologically.

With this in mind, Avelino provides ample discussion on the oppositions that exist in Northern Pame. These oppositions can be lexical or exclusively morphological and contain the following phonological oppositions: *neutral* (the base form), *palatal*, *nasal*, *aspirated*, *glottalized* and *voice*. The representation in figure 3 represents Avelino's five phonological oppositions that can potentially be present for a Northern Pame consonant.

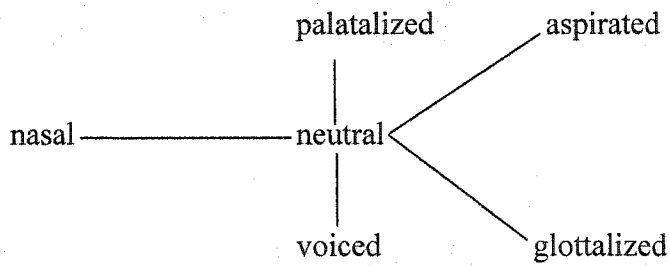

FIGURE 4-1. Contrast of oppositions (Avelino 1997:80)

For example, looking at figure 4-2, we see the oppositions possible for the class of bilabials.

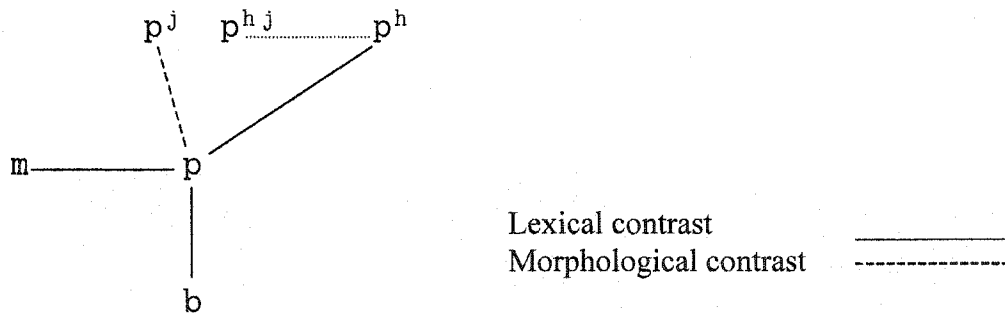

FIGURE 4-2. Bilabial oppositions (Avelino 1997: 82)

Bilabial consonants are based on the neutral consonant /p/. According to this approach, he determines lexical contrasts for voicing, nasality and aspiration, while

glottalization for bilabials is unattested. Words such as /npǎjɔl/ ‘horse’ (base form), /basá/ ‘corn cobs’ (voicing), /masá/ ‘corn cob’ (nasalization), and /np^húju/ ‘chair’ (aspiration) exemplify the opposition of bilabials. Notice that a palatal bilabial stop is possible only in a morphological environment (i.e. consonantal mutation) where it contrasts with the neutral form. The aspirated palatal bilabial stop contrasts with the aspirated bilabial stop, again under morphological conditions only such as in /np^húju/ ‘chair’ and /p^hjúju/ ‘chairs’.

In summary, Avelino clarifies the issue left unanswered by earlier Pamean studies by asserting that Northern Pame ambiguous sequences are in fact, complex consonants. Moreover, he maintains that complex consonants can be of two types, lexical and morphological where the latter may contain the former, but not vice versa. This is a step in the right direction, but as the present research will illustrate in the next section, a lexical-morphological opposition model is inadequate.

4.2.3. *Critique of previous approach*

The lexical-morphological opposition claim for Northern Pame consonants is challenged in this dissertation based on the fact that there are many words that contain complex segments that are not morphologically derived. That is not to say that complex segments do not occur at morpheme boundaries, but rather that they are not limited to these environments. Furthermore, the present research maintains that in any morphological derivation, only lexically contrastive segments may surface, rather than a mix of both morphological and lexical ones.

To begin, let us consider the segmental units that Avelino claims are morphological oppositions only (1997: 82).

(6) Lexical~morphological oppositions

/t^h/~/ʎ/ /l~/ʎ/

/t'~/~/tʃ' / /p^h/~/p^hj /

/tʃ^h/~/~/tʃ^h/ /p~/~/p^j/

/tʃ'~/~/tʃ' / /m~/~/m^j, m^hj /

In the morphological-lexical model, the claim is that the oppositions in (6) will only be found among morphologically mutated consonants, not lexical ones. The validity of this claim can be tested by comparing it to elicited data. As it turns out, such oppositions are also consistent among lexical contrasts.

(7) Examples of consonants in (6) that are not morphologically derived.

/t^h/~/ʎ/ /nt^húj/ 'woman' /ʃiʎə/ 'humming bird'

/t'~/~/tʃ' / /nt'ǎ/ 'mesquite tree' /ʃtʃ'é?/ 'tortilla plate'

/tʃ^h/~/~/tʃ^h/ /ʃitʃ^huǎ/ 'thigh' /gutʃ^hé?/ 'snake'

/tʃ'~/~/tʃ' / /ʃtʃ'é?/ 'tortilla plate' /ntʃ'ǎwn' / 'avocado'

/l~/ʎ/ /balé/ 'many, much' /ʃiʎə/ 'humming bird'

/p ^h /~/p ^h j/	/np ^h úhu/	'chair'	/stəp ^h jút/	'basket'
/p/~/p ^j /	/dəmpú/	'black'	/gəmp ^j ú/	'firework'
/m/~/m ^j , m ^h j/	/nməʔp/	'donkey'	/nm ^h jéʔn/	'soup'

The data in (7) provide evidence of lexical contrasts for segments or sequences that Avelino claims to be strictly morphological (6). For example, the lexical-morphological model asserts that /t^h/ may contrast in both non-morpheme and morpheme boundaries, while /ʔ/ only appears at morpheme boundaries. However, the examples in (7) show that both /t^h/ and /ʔ/ can appear in morphologically non-complex contexts.

In summary, the lexical-morphological approach to Northern Pame segments overgenerates. As the following chapters will illustrate, consonant coalescence is a productive morphological process in Northern Pame and a high number of segmental contrasts are found in these specific environments. However, morphological boundaries are not the exclusive domain for certain morphological segments, but rather the environment for richest amount of lexical contrast.

4.2.4. *The non-segmental status of ambiguous sequences.*

Although the oppositions mentioned above are lexical, there is still ambiguity as to which are truly phonemic segments and which are sequences. Specifically, these cases involve: 1) palatalized labials and palatalized laryngeals, and 2) labialized velars and labialized laryngeals, which this research considers to be purely sequential in underlying form.

TABLE 4-3. Unambiguous compared to ambiguous segments

UNAMBIGUOUS SEGMENTS			AMBIGUOUS SEGMENTS		
/p/	/b/	/t/ /d/	/k/ /g/	/ʔ/	/pʲ/[pʲ] /bʲ/[bʲ]/kw/[kʷ] /gw/[gʷ]
/pʰ/	/tʰ/ /tʼ/		/kʰ//kʼ/		/pʰʲ/[pʰʲ] /kʰʷ/[kʰʷ]/kʷ/[kʷ]
	/t͡s/	/t͡ʃ/			/mʲ/[mʲ]
	/t͡sʰ//t͡sʼ//t͡ʃʰ//t͡ʃʼ/				/mʰʲ/[mʰʲ]
	/s/	/ʃ/		/h/	/hʲ/[hʲ] /ʔʲ/[ʔʲ]
/m/	/n/	/ɲ/			/hʷ/[hʷ] /ʔʷ/[ʔʷ]
/mʰ//mʼ//nʰ/	/nʼ/	/ɲʰ/ /ɲʼ/			
	/r/	/rʲ/			
	/l/	/ʎ/			
	/lʰ/ /lʼ/	/ʎʰ/ /ʎʼ/			
/w/		/j/	/h/ /ʔ/		

These issues of unit versus sequence cannot be solved exclusively in the phonetics because the physical properties involved in producing either of these ambiguous segments/sequences are basically the same in Northern Pame.²⁵ Therefore, we must rely on additional phonological evidence of which the most important to consider is their distribution. The criteria used here for the distribution of unit phonemes is summarized in (8).

²⁵ Hence, Manrique (1967) and Gibson (1956) strictly write all such examples as a consonant plus a glide. Avelino (1997) takes an alternate course by positing a series of onglide diphthongs. Thus, ʃilie¹ is transcribed as ʃilie¹ ‘humming bird’, gəpʲēn as gəpiēn ‘scorpion’, and bʲúʔ as biuʔ ‘def.art inanimate’. However, no justification is provided for this approach.

(8) Distribution of unambiguous segments

a. #__V 'Word initially before a vowel'.

b. V__V 'Intervocalic position'

c. VC__V 'Onset of a medial cluster'

d. V__# 'Word final coda position'

Unambiguous consonantal units tend to pattern according to the environments in (8a)-(8d).

The data in (9) illustrate some common examples of the distribution of unambiguous segments.

(9) Distribution of unambiguous segments

#__V	/tʃɑ̃ʔ/	'clearings'	/ɲuæ/	'guns'
V__V	/pitʃɑ̃ʔ/	'corn storehouse'	/ɾiɲæp/	'your livers'
VC__V	/kəntʃæ/	'his water'	/ʃiʔɲũɑ̃/	'his nose'
V__#	/mɑntʃɑ̃tʃ/	'they will set.soft'	/sɛɲ/	'he washes'

The data in (9) show the distribution of two unambiguous segments, which are an alveo-palatal affricate and a palatal nasal. Both fully distribute in word initial, intervocalic, post-consonantal and word final positions.

Now let us examine the distribution of ambiguous sequences of bilabial consonants followed by a palatal glide in (10) and laryngeal consonants followed by either a palatal glide

or a labio-velar glide in (11).

(10) Distribution of ambiguous palatalized bilabials

#_V /pǰúʔ/ 'lands' /mjǰhaw/ 'his stomachs'

V__V /rǰpǰǎj/ 'your tomatoes' /nǰmjǰǎwʔje/ 'we.Dl.made a complaint'

VC__V /k'ǰpǰúʔ/ 'you descended' /rǰmjǰǎhǰjʔ/ 'his squashes'

V_# -----

(11) Distribution of ambiguous labialized velars/laryngeals

#_V kwǎ 'pron.' hwǎtʃ 'he hunts'

V__V sǎkwǎ 'my thigh' guhwǎw 'reed'

VC__V lǎnkwǎl 'I pour' tǎhwǎw 'I pay'

V_# -----

In (10), the palatalized voiceless bilabial stop and palatalized bilabial nasal distribute for word initial, intervocalic and post-consonantal positions, but not word finally. The ambiguous labialized sequences in (11) distribute in the same way. Therefore, segmentation of these questionable sequences is disambiguated only at the coda/word final position. This is a significant detail since bilabial stops, velar stops and nasal consonants can appear word finally in Northern Pame. However, the fact that their ambiguous palatalized or labialized counterparts do not offers credence to their sequential segmentation.

4.2.5. *Additional evidence for true complex segments*

Additional data is given in (12) for other unambiguous segments in word final position contrasted with their plain alternates.

(12) Complex segments in coda position

* /k/~/k' /	ʎúŋk	'my chicken'	ʎũŋk'	'your chicken'
/tʃ/~/tʃ' /	lɛʔátʃ	'I kick'	lɛgwátʃ'	'I fall'
/tʃs/~/tʃs' /	n'káʃs	'you are about to set.soft'	spɛháwʃs'	'pretty'
/n/~/n' /	mǎn	'he wants'	tɛʔǎhawn'	'I ask'
/l/~/ʎ/	npáhal	'horse'	gusǎʎ	'eagle'

The data in (12) confirm a unit approach for a number of otherwise ambiguous sequences. First, glottalization is contrastive for velar stops, alveo-apical, alveo-palatal affricates and nasals.²⁶ Second, palatalization is contrastive among the affricates and laterals. Thus, there is some, albeit, a limited set of distributional evidence for complex segments. Based on this evidence, the following gestures be interpreted as units with their adjacent consonants: glottalization, aspiration, coronal-palatalization.

²⁶ Northern Pame nasals neutralize to one place of articulation in coda position. The alveolar nasal represents any nasal coda.

4.3. Segmentation of vowels

4.3.1. *Laryngeally ambiguous vowels*

Northern Pame, like other Otomanguean languages, is ambiguous for laryngealization on its vowels, which are termed in this dissertation as “laryngeally ambiguous”. A simple vowel nucleus may possess any of the contrastive vowel quality features exemplified in chapter 3 and is produced with modal phonation of the vocal folds. In contrast, laryngeally ambiguous vowels surface as two modal voice phases with an interrupted laryngeal gesture.

For example, figure 4-3 is an example of a simple vowel produced with modal voice. The duration of the vowel /ɑ/ in ‘cow’ is approximately 125 milliseconds and shows regular modulated pulsation of the vocal folds. In figure 4-4 ‘his chair’, the vowel quality /u/ appears on both sides of a laryngeal fricative /h/ with a total duration of approximately twice that of /ɑ/ in ‘cow.’ The /h/ is identified here by the cessation of periodic vocal fold vibration, and a high degree of frication. Notice that modal voice is persistent through the first phase of the vowel, while it becomes somewhat more aperiodic in the second phase. The facts for a vowel bifurcated with constricted glottis are more or less the same as in figure 4-5 being identified by the wider striations of vocal pulses.

The phonetic facts of vowels such as those in figures 4-4 and 4-5 leave open the question of their proper phonological segmentation. Because these vowels always have the same vowel quality on both sides of the laryngeal gesture, one might consider these to be unit phonemes with two modal voice phases interrupted by non-modal voice quality.

p e g a s

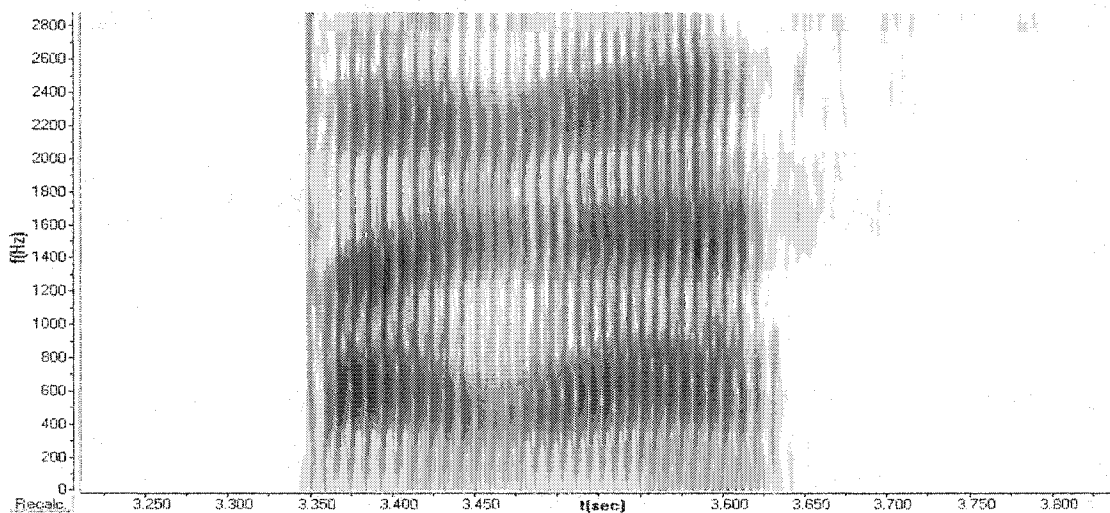

FIGURE 4-3. Spectrogram of a simple /ɑ/ vowel in 'cow'

n p u h u

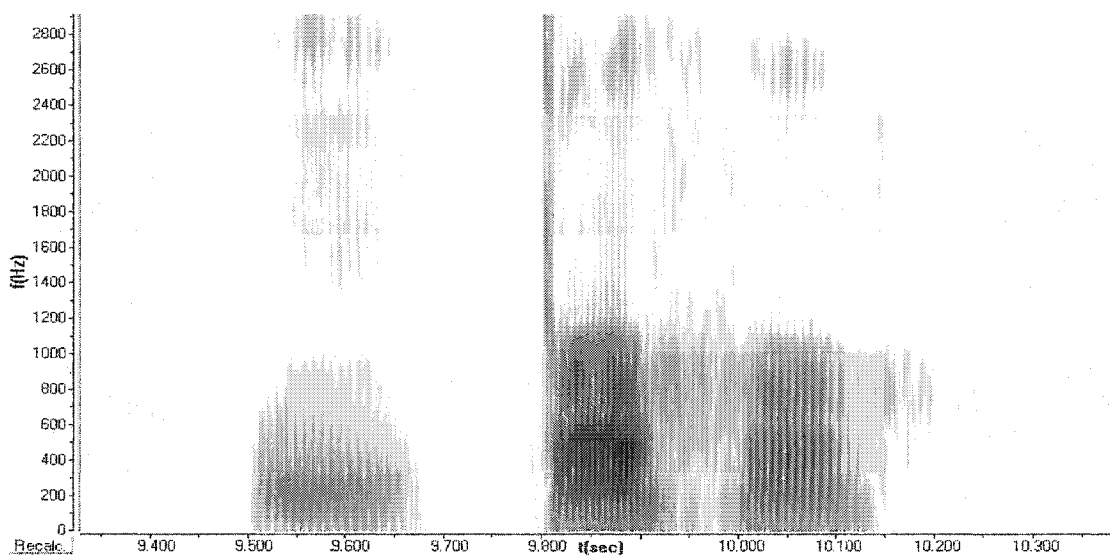

FIGURE 4-4. Spectrogram of a laryngeally ambiguous /u/ vowel for breathy voice in 'his chair'

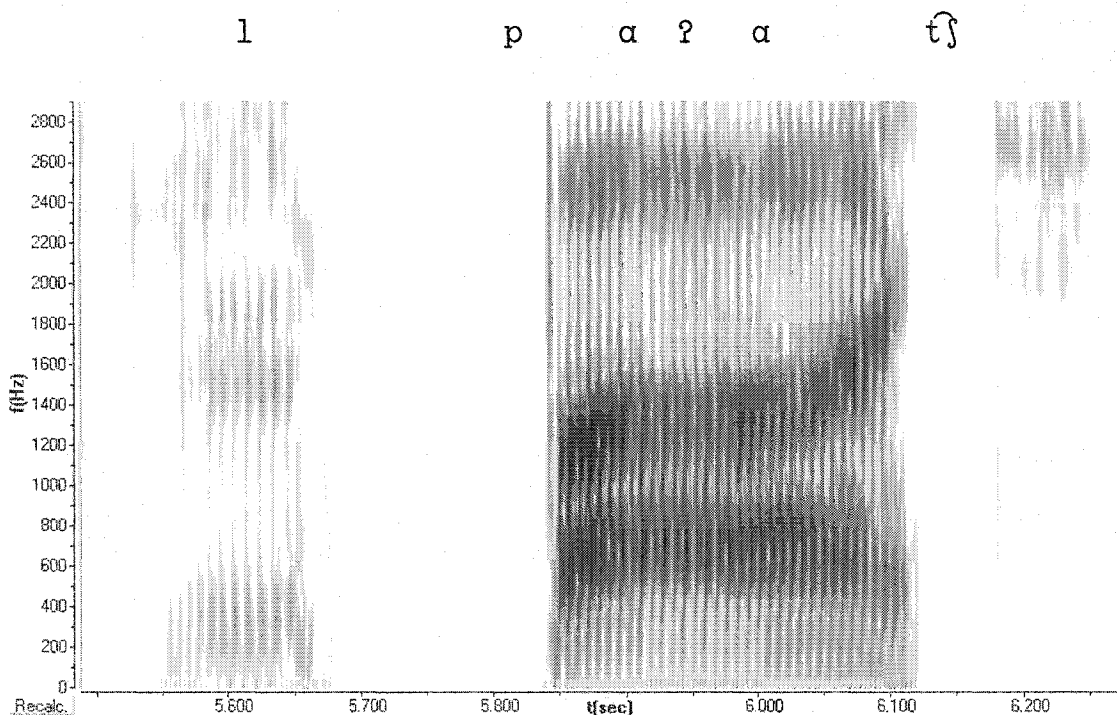

FIGURE 4-5. Spectrogram of a laryngeally ambiguous /ɑ/ vowel for creaky voice in 'I help'

However, the facts also show these vowels to be more than twice as long as a simple vowel, which would warrant a sequence approach. Thus, any analysis that purports to be conclusive on this question must go beyond the phonetics and be justified in the phonology regarding laryngeally ambiguous vowels.

4.3.1.1. Unit as laryngeally complex

The unit approach to laryngeally ambiguous vowels in Otomanguean languages is not new. Longacre (1957) views these vowels as units ($/V^2V/$, $/V^hV/$) compared to other sequences ($/V//ʔ/V/$, $/V//h/V/$) in his description of Chichahuaxtla Trique.

A vowel medially checked with /ʔ/ differs structurally from two vowels of the same quality separated by /ʔ/ and occurring in successive syllables. In the latter case, the second vowel element is sub-phonically lengthened in word final as are all unchecked vowels; while in the former case both vowel elements are pronounced with considerable rapidity (75, footnote 2).

This topic has been more recently taken up by Silverman (1995) and further elaborated in (Silverman et al. 1995, Silverman 1997b, and Herrera 2001). These researchers have made the claim that laryngeally interrupted vowels are best understood phonologically as units described as breathy or creaky vowels.

Based on a study of perceptual salience (as compared to articulatory ease), Silverman (1995) makes two important observations, 1) that tone is most easily recoverable during modal voice phonation, and 2) that Otomanguean languages, which are typically tonal, also have laryngeal gestures related to their contrastive nuclei. Thus, he suggests that if we posit that the underlying vowel is laryngeally complex, that is either breathy or creaky, then there is clear motivation for these gestures to be sequenced either before, after, or in the middle of a vowel in order to preserve pitch saliency on the modal portion:

...tone is most salient when occurring with modal voice. Consequently, in laryngeally complex vowels tone and non-modal phonation are sequenced, produced serially, so that tone may be realized with modal voice (1997: 92).

Silverman illustrates his phasing and recoverability model (1997) with the Otomanguean languages of Jalapa Mazatec, Comaltepec Chinantec, and Copala Trique²⁷ and concludes that the presence of laryngeally interrupted vowels as those described in Longacre (1957) implies

²⁷ Silverman names his data Copala Trique which appears to be an error. The argumentation and data which he largely surmised from Longacre (1957) is from Chicahuaxtla Trique, a separate dialect with less than 50% intelligibility from Copala Trique. Among the differences, Copala Trique does not have laryngeally interrupted vowels, and unlike Chicahuaxtla Trique, it does have contrastive /h/ prevocally, in contrast to Silverman's claim (1997:243).

the presence of prevocalic laryngeals and postvocalic laryngeals. He illustrates his conclusion in the following chart repeated from chapter 2.

Table 4-4. Silverman 1997:245 (repeated)

	PREVOCALIC	POSTVOCALIC	INTERRUPTED
JALAPA MAZATEC	hVɿ, ʔVɿ	-	-
COMALTEPEC CHINANTEC	hVɿ, ʔVɿ	Vhɿ, Vʔɿ	-
COPALA TRIQUE	hVɿ, ʔVɿ	Vhɿ, Vʔɿ	VhVɿ, VʔVɿ

Finally, Silverman makes the strong claim that vowel breathiness should not immediately follow an aspirated consonant even in a phonological system where the two are contrastive.

The rarity of this contrast is most likely a consequence of the difficulty in maintaining a sufficiently salient distinction between the two configurations (1995: 102).

Silverman's unit approach to laryngeally ambiguous vowels has been further applied to Amuzgo and Zapotec in Herrera (2001). In the case of Amuzgo, Herrera reinterprets the notion of a ballistic syllable as a manifestation of breathiness [+spread glottis] on the vowel. The phonetic effect is one similar to a vowel followed by a laryngeal fricative /h/. However, Herrera interprets these facts as one where breathy voice is phased after modal voice as a means to insure optimal recoverability of tonal contrasts. She terms such a phasing, the "Solomonic effect" (553).

Regarding Zapotec creakiness, Herrera challenges Silverman's claim that non-modal

voice features cannot co-occur with tone in Otomanguean languages (Silverman 1995: 92, Herrera 2001: 558). This is demonstrated with Zapotec where she concludes that “the aperture of the creaky vowel is reduced, but still enough to allow for laryngealization, [so that] tone can continue also” (558).

4.3.1.2. *Autosegment*

The second approach to laryngeally ambiguous vowels is represented in analyses such as those by Hollenbach (1984), McCaulay and Salmons (1995) and Meechan (1990) where the authors claim laryngealization to be a floating feature based on Autosegmental phonology. Hollenbach, for example finds evidence for tonal alternations with post-vocalic /h ʔ/, while laryngeal onsets clearly pattern as consonantal segments (30-31). Based on this evidence, Hollenbach posits both laryngeal autosegments (those that interact with tone on a laryngeal/tonal tier) and laryngeal segments /h ʔ/.

McCaulay and Salmons (1995) observe that glottal stop is contrastive only on Mixtec roots. Since Mixtec may have roots such as CVʔ and CVʔV they argue that a floating glottal stop feature attached to the left vowel of a root will simplify earlier accounts, which posit a contrast between a glottalized and plain vowel (49). They conclude that where a vocalic glottal stop would double the vowel inventory (58), their analysis allows for a more economical and hence, preferable approach to Mixtec glottalization.

4.3.1.3. *Root-plus-formative*

With regard to Northern Pame, only Avelino (1997) broaches the subject of laryngeally ambiguous vowels. Regarding such forms as those in figures 4-4 and 4-5,

Avelino maintains that these are best understood as a “formative” on the root to form a stem (109). However, he gives no definition as to the meaning of this formative, if indeed it has morphological meaning at all.

4.3.2. *Critique of former approaches*

Laryngeally ambiguous vowels in Northern Pame appear quite similar to those outlined in the unit and Autosegmental approach for Trique, Zapotec, Amuzgo and Mixtec, yet there are a number of unanswered questions to these previous analyses. With regard to the unit approach proposed by Silverman (1995), the postulation of underlying breathy and creaky vowels depends on one crucial phenomenon, the presence of tone. However, data exist from non-Otomanguean as well as Otomanguean languages that prove that tone can be produced simultaneously with non-modal creaky voice, as Silverman as well as Herrera both mention. Regarding the reason as to why certain Otomanguean languages do *not* allow simultaneous tone and non-modal voice, Silverman and Herrera both claim that laryngeal and pitch gestures are *both* produced in lesser degree and hence, they are able to co-occur (Silverman 1997b: 247, Herrera 2001: 558). This argumentation appears to be unconvincing and in fact circular (tone and voice quality are incompatible thus triggering laryngeal sequencing, except in languages where they are compatible).²⁸ That is not to say that laryngeally ambiguous vowels are not units in these languages, but only that the postulation of tone as the key cause for laryngeal sequencing is yet to be definitively proven. As the data of Northern Pame demonstrate below, this present research maintains that syllable phonotactics must also be considered.

²⁸ In fact, other Mexican language exhibit laryngeal vowel sequencing that are *not* tonal. For example, Isthmus Mixe (Herrera, p.c.) has this characteristic with no contrastive tone.

The Autosegmental approach, while attempting to simplify the syllable complexity of the laryngeal root in Mixtec and Trique, does so by adding a new [auto]segment to the inventory. This approach has merit in their data set, since Mixtec apparently has no true glottal stop segments and laryngeal segments in Trique are limited to onsets.²⁹ However, Northern Pame laryngeals are clearly segmental in the phonology, appear outside the root, and do not alternate with tone. Thus, an Autosegmental approach does not have direct application to the data facts in any way that seems directly useful.

Finally, the root-plus-formative approach maintained by Avelino (1997) clearly sees these vowels and laryngeals as sequences of separate segments. He claims that the second vowel is a reduplicant or copy of the first (Avelino 1997: 109) in much of the same spirit as other Pame linguists (Soustelle 1937, Gibson 1956, Manrique 1967). However, while this dissertation agrees with interpreting these data as vowel/laryngeal sequences, the data in the following analysis suggest that the first vowel rather than the second is the copy vowel.

4.3.3. Reanalysis of laryngeally ambiguous vowels

Northern Pame laryngeally ambiguous vowels are best interpreted as a sequence of two vowels with an intervening laryngeal segment. In addition to the phonetic facts already mentioned above, this research appeals to phonological criteria as well. First, the bisyllabic nature of these data is confirmed by native speaker intuition and production. Second, laryngeally ambiguous vowels are shown not to lengthen in identical tonal environments as do unambiguous vowels. On the contrary, these vowels pattern with tone in exactly the same way as a root followed by another syllable. Third, in at least one domain, the first

²⁹ This is according to Hollanbach's approach. Longacre (p.c. 2003) maintains that Trique has segmental glottal stop codas.

vowel/phase of laryngeally ambiguous vowels manifests epenthetic qualities where, regardless of the quality of the second vowel, the first will always raise to /i/ during morphological palatalization. Such evidence supports a claim of vowel epenthesis breaking up an ill-formed consonant cluster.

4.3.3.1. Syllabification

As illustrated in figures 4-4 and 4-5, laryngeally ambiguous vowels in Northern Pame are capable of a duration more than twice that of a single vowel. This fact alone contrasts sharply with those found in Chicahuaxtla Trique laryngeally complex vowels defined as two vowels spoken with “considerable rapidity”. In (13), we see additional forms and the syllable breaks the Northern Pame speakers made when asked to produce these data in isolation.³⁰

(13) Syllable breaks of laryngeally ambiguous vowels

	List word	Syllabified form	
C.CV.CV	/nmæhæ/	/n . mæ . hæ/	'his cargo'
C.CV.CV	/np ^h úhu/	/n . p ^h ú . hu/	'chair'
C.CV.CVC	/nm'áhaw/	/n . m'á . haw/	'stomach'
CV.CV	/læʔæ/	/læ . ʔæ/	'he resurrects'
C.CV.CVCC	/ntseʔént/	/n . tse . ʔént/	'it isn't there'

³⁰ These syllables are phonetic as the speakers produce them in list form.

CVC.CV.CV /təʔhúʔu/ /təʔ.hú.ʔu/ 'I am able'

The long duration of these VhV, VʔV sequences is not accidental, which these data support. Rather, their duration appears to be motivated by the underlying existence of one vowel followed by a laryngeal onset and then a following vowel. However, these surface data can only give us a first approximation of the phonological form of these segments, since the surface forms may very well be dictated by other phonological constraints.

4.3.3.2. *Laryngeally ambiguous vowels and tone*

Further evidence as to the sequential function of laryngeally ambiguous vowels comes from their interaction with Northern Pame morphological tone and the productive process of compensatory lengthening.

Northern Pame nouns are morphologically marked for possessor in a number of ways including that of tone in combination with a class of possessor prefixes (T=tone).³¹

TABLE 4-5. Morphological tone for noun possession.

	PREFIXES	TONE (LEXICAL ROOT)
UNMARKED	-	T
FIRST PERSON POSSESSOR	n-ʔw-	T
SECOND PERSON POSSESSOR	n-əj-	opposite of T
THIRD PERSON POSSESSOR	n-ʔj-	T

The one defining mark of Northern Pame tone is that it is only contrastive on the lexical root.

³¹ The reader will notice that the vowels in these prefixes are subject to reduction/deletion in the phonetic data. This process will be discussed in chapter 8.

In the prefix class for noun possession, the tone is always the same for the unmarked, first person and third person forms. As illustrated in table 4-5, the second person always receives the opposite tone of the other three.

As discussed in chapter 3, rising tone always has predictable compensatory vowel lengthening on the root vowel just when no post-lexical root syllable is present. This same vowel length allophony predictably occurs in the possessive nouns.

(14) Vowel length with rising tone on possessive nouns (simple root vowel).

HIGH TONE		ACCENDING TONE	
[niŋá:s]	'your orange'	[nʔnǎ:s]	'my orange'
[n'kwás]	'my cow'	[netʃǎ:s]	'your cow'
[n'tʰúʔ]	'my armadillo'	[ntʃhǔ:ʔ]	'your armadillo'
[nʰtʃséʔ]	'my bean pot'	[nʰtʃsě:ʔ]	'your bean pot'

In (14), some contrasts of tone have been illustrated in possessive nouns where the second person possessor 'your ...' is always the opposite of the first person possessor 'my ...'. Likewise, notice that the vowel always lengthens in these examples since there is no post-lexical root syllable available. The wave forms and pitch contours for 'your orange' (high tone) and 'my orange' (rising tone) in the next waveforms.

The difference in vowel length between /ǎ/ /ǎ:/in 4-6 and 4-7 is roughly 150 milliseconds in duration. We can compare compensatory vowel lengthening of unambiguous

vowels with their laryngeally ambiguous counterparts to see if the latter are phonologically treated as monosyllabic or bisyllabic.

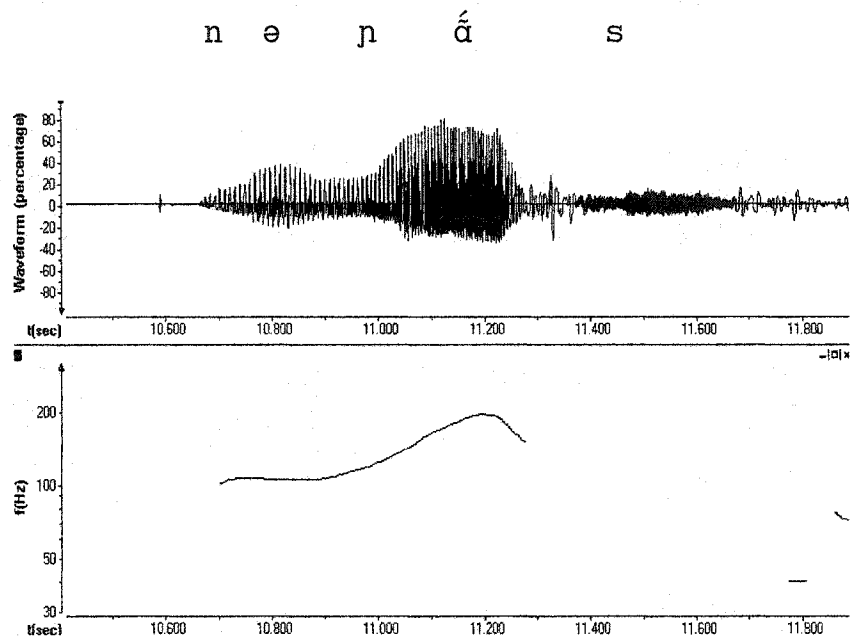

FIGURE 4-6. Waveform and pitch contour for 'your orange'

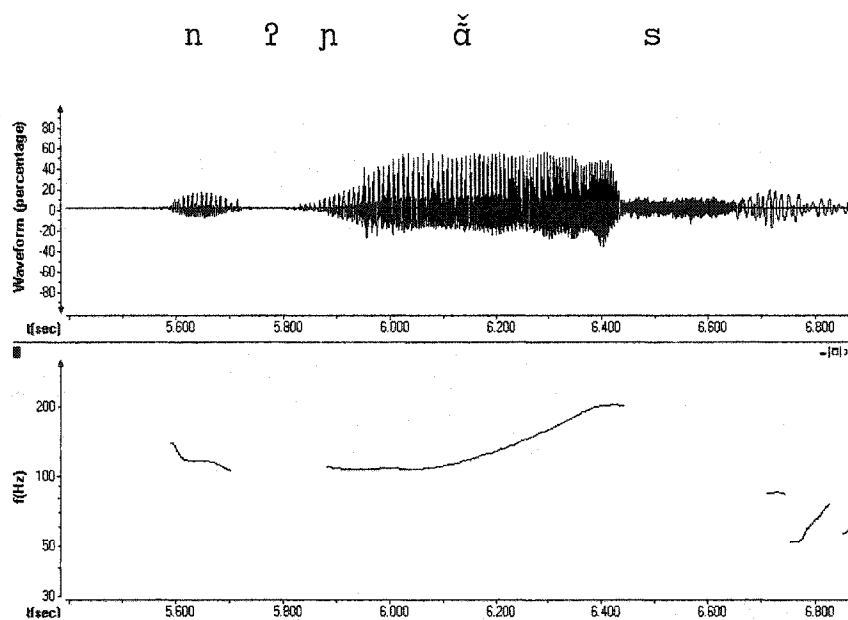

FIGURE 4-7. Waveform and pitch contour for 'my orange'

As the facts in (15) illustrate, laryngeally ambiguous vowels undergo no compensatory lengthening with rising tone.

(15) Rising tone on laryngeally ambiguous vowels.

/n^hpúhu/ [n^hpúhù] 'my chair' /n^hpǔhu/ [n^hpùhú] 'your chair'
 /nʔnǎʔæp/ [nʔnǎʔəp] 'his liver' /niɲǎʔæp/ [niɲǎʔəp] 'your liver'

The laryngeally ambiguous vowels syllabify as two nuclei and the rising tone (low-high) spreads as a phonetic low-high pitch over the two vowels with no observable lengthening.

This is further illustrated in the examples in figures 4-8 and 4-9.

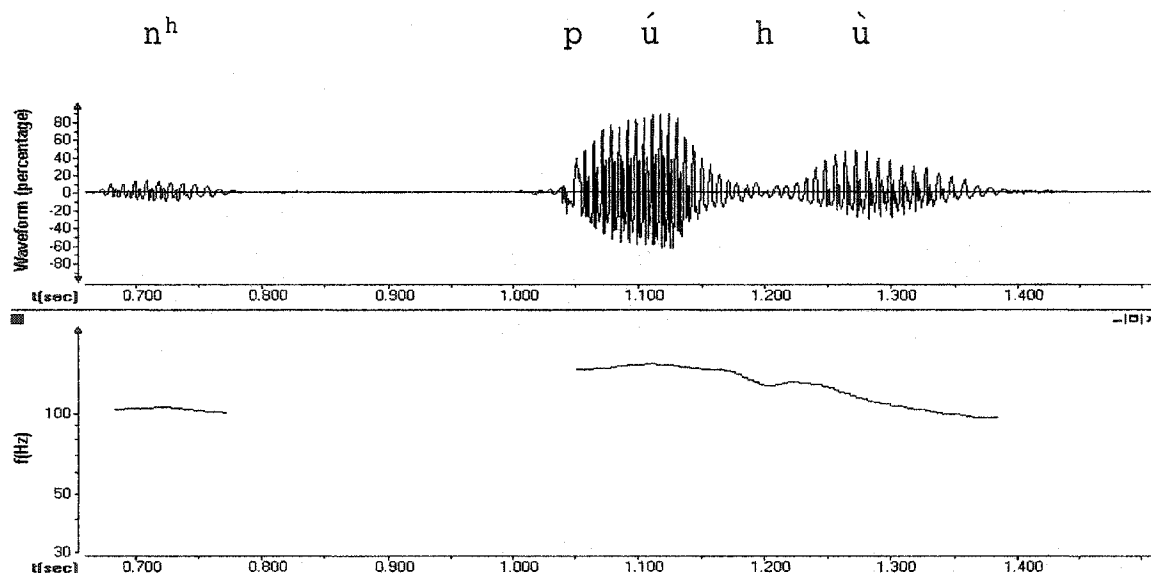

FIGURE 4-8. Waveform and pitch contour for 'my chair'

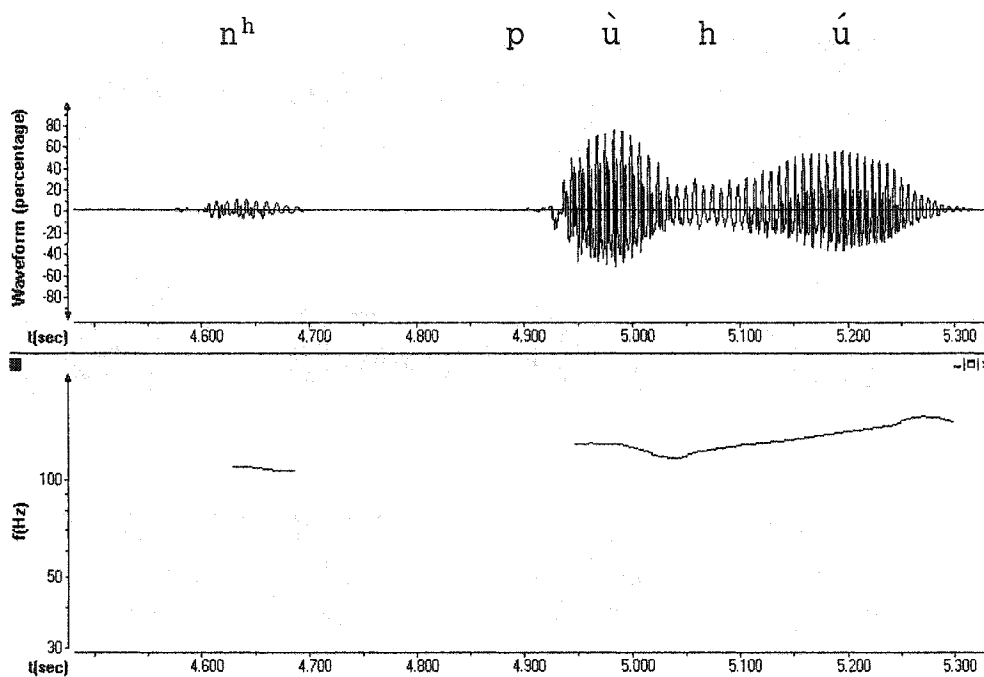

FIGURE 4-9. Waveform and pitch contour for 'your chair'

Both waveforms in figures 4-8 and 4-9 have an approximate duration of 350 milliseconds for the laryngeally ambiguous vowels or 125 milliseconds for each vowel in the sequence; hence there is no observable change in vowel length. However, as the pitch contours illustrate there is a discernible contrast in pitch.

In addition, it should be noted that the pitch contours in figures 4-8 and 4-9 pattern in exactly the same way as data that contain a post-lexical root syllable. In examples such as 'cat' versus 'cats' (16), there is no vowel lengthening in the suffixed plural form although both singular and plural have a rising tone. The reason that no compensatory lengthening occurs is that the plural suffix is available to receive the high pitch of the rising tone.

(16) Accending tone with no compensatory lengthening

SINGULAR		PLURAL (SUFFIX FORM)			
/nmĩs/	[nmĩ:s]	'cat'	/mĩsət/	[mĩsət]	'cats'

In summary, vowel compensatory lengthening lends support to the evidence by Northern Pame speakers that laryngeally ambiguous vowels are truly sequences of two nuclear vowels with an intervening laryngeal segment.

4.3.3.3. *Vowel quality*

If laryngeally ambiguous vowels are a sequence of two vowels, the next question to ask is if they are strictly historical artifacts that the language learner must memorize, or if they are part of the active synchronic system of Northern Pame. The evidence in this section suggests the latter where the first vowel of the sequence in question behaves as an epenthetic vowel. Consider (17) where the data illustrate potential palatalization on a root that begins with a labial consonant.

(17) Glide vocalization

PREFIX	ROOT	2ND PERSON PALATALIZATION	
/k'əj-/	/pəhæ/	/k'əpíhæ/	'you carry'
/k'əj-/	/páʔatʃ/	/k'əpíʔatʃ/	'you help'
/kəj-/	/páhaw/	/k'əpíhaw/	'you watched'

/n-j-/	/pǎhǎp/	/nǎbǐhǎp/	'you provoked'
/n-j-/	/pǎʔatʃ/	/nǎbǐʔatʃ/	'you helped'
/k'ǎj-/	/mǎhu/	/k'ǎmǐhu/	'you live'
/k'ǎj-/	/mǎʔǎ/	/k'ǎmǐʔǎ/	'you shout'

The data in (17) illustrate an important fact about the initial root vowel. During palatalization where the initial root consonant is bilabial, the palatal morpheme raises the *initial* vowel of the root to /i/ rather than coalescing with the initial root consonant. The fact that these bilabial consonants do not palatalize is to be expected since there is a constraint prohibiting palatalized bilabials as true lexical segments. For example, when a bilabial consonant is followed by a single vowel, glide insertion is preferred (18).

(18)	ROOT	2ND PERSON PALATALIZATION	
	/pǎ/	/nǎʔpjǎ/	'you completed'

However, glide insertion is precluded by vowel raising just when a sequence of VʔV, or VhV follow a bilabial consonant (17). This fact clarifies our understanding as to which vowel is the copy and which is the source. The data in (17) suggest that the first vowel is a copy of the second supported by the fact that it is susceptible to feature assimilation, in this case, that of palatalization. Therefore, in the absence of such a process, the default vowel

quality of the first vowel in these sequences will be a copy of the second, which is the underlying vowel.

Additional data that support this line of reasoning for Northern Pame comes from the now extinct Southern (Jiliapan) Pame documented by Manrique (1967: 338). Again, the first vowel in the ambiguous sequence surfaces as a high front vowel during a palatalization process. Just as in Northern Pame, vowel raising applies only on a root initial bilabial consonant followed by VʔV or VhV.

(19) Vowel raising in Jiliapan Pame (Manrique 1967)

/páʔat/	/píʔat/	'I am helping'
/puhin/	/pihin/	'I am covering'

In conclusion, the evidence supporting an epenthetic vowel as the first in a [laryngeal] sequence of vowels begs the question as to the cause of epenthesis. This question will be taken up in chapter 5 where it is maintained that these vowels break up a prohibited cluster of /Cʔ/ or /Ch/.

4.4. Conclusion

In summary, segmentation of Northern Pame consonants and vowels poses a challenge for researchers. For consonants, this study concludes that all but palatalized labials and laryngeals and labialized laryngeals and velars should be interpreted as units. With this in mind, Northern Pame has a consonantal inventory of 40 segments.

Regarding vowels, the Northern Pame data support a sequence approach to

laryngeally ambiguous vowels and moreover, this dissertation suggests the existence of an epenthetic vowel (the first vowel in a sequence of VʔV and VhV. Therefore, including nasals Northern Pame has a total of 12 vowels.

CHAPTER 5

SYLLABLE STRUCTURE

5.1. Introduction

The preservation of syllable structure can motivate various phonological changes including deletion, epenthesis and coalescence, yet these processes can be accounted for in different ways. In a derivational theory, a well-formed syllable is the end product after a series of rules have been applied to some intermediate underlying form, with syllabification processes comprising one component of the phonological grammar. In contrast, in a constraint approach a number of surface candidates are evaluated by markedness and faithfulness constraints, the winning candidate being that one which has the most minimal constraint violations. Crucial to this second approach is the notion that syllable well-formedness, like all other constraints, applies to the surface candidates and not to underlying forms.

In looking at possible Northern Pame surface syllable patterns we see the following types: V, VC, VCCC, CV, CVC, CCVC, CCVCC, CCCVC, CCCVCC, CVCC, CVCCC, CCVCCC, CCCVCCC. Although these patterns tell us something of the exhaustive possibilities of Northern Pame syllables, they say nothing about what segments are allowed in syllable constituents.

There are several cross-linguistic notions about syllables that this dissertation deals

with. First, there is the issue of constituent complexity. CV syllables are universal among the world's languages, while CVC syllables are universal among coda languages (Hyman 1975, Itô 1989, Kager 1999). CCV, CVV or CVCC types are examples where syllable onsets, nuclei and/or codas can be made up of more than one segment. Such syllable constituent complexity is the marked case cross-linguistically. However, no language that contains complex constituents does so without constraints. For example, in Northern Pame, there are 40 consonants, which if randomly combined to form CC onsets would produce 1600 possible onset combinations. However, of these possibilities only 31 CC onsets are attested in the language facts. Therefore, we want to discover what forces constrain the grammar to just a limited number of allowable syllable constituent phonotactics.

Another syllable related topic in Northern Pame is the phonotactic prohibition of oral vowels before nasal codas. As illustrated in previous chapters, Northern Pame nuclei are contrastive for nasalization, a fact which can be seen in complete and partial minimal pairs. However, this phonological distinction conflicts with articulatory factors just when a nasal consonant coda follows an oral vowel. In these combinations, the nasal consonant becomes partially denasalized as a way to maintain the contrastiveness of the oral vowel. The analysis that follows suggests an ordering that allows consonant nasal settings to be violated before vowel nasality in a formal constraint ranking.

Finally, Northern Pame allows for consonant codas, which are marked typologically (Itô 1989, Kager 1999). However, the consonants that are allowed in codas are severely constrained as are coda consonant clusters. In addition, place of articulation is shown to be non-contrastive on nasal codas.

/p ^h j/	/p ^h jáʦʰ/	'shoes'	/ʔw/	/ʔwúʦʰ/	'he writes'
/bj/	/bjúʔ/	'def.art.inam.'	/ʔj/	/ʔjús/	'my houses'
/kw/	/səkwǎ/	'my thigh'	/hw/	/nəhwáʦʰ/	'I lifted.heavy'
/k ^h w/	/nk ^h wǎ/	'rabbit'	/hj/	/hjéʔ/	'you.sg'
/gw/	/nəgwǎn/	'I shot'	/mj/	/nmjáħw/	'his stomach'

In addition to the consonant+glide clusters, oral and nasal stop consonants may be preceded by the alveolar and alveo-palatal fricatives.

TABLE 5-2. Possible onsets on lexical morphemes.

C	All consonants			
CC	/sp/	/st/		/sk/
		/st ^h /	/st'/	/sk ^h / /sk'/
		/stʃ/	/stʃʰ/	
		/stʃ ^h /	/stʃ'/	/stʃʰʰ/ /stʃʰ'/
	/sm/	/sn/		/ʃn/
CCC	/ʃpj/		/skw/	

An important observation regarding the clusters in table 5-2 is that the fricative agrees with the following obstruent for anteriority (alveolar versus alveo-palatal). In addition, the fricatives may precede nasal stops and furthermore, three consonant clusters composed of a

either a fricative with a voiceless bilabial+palatal cluster or a voiceless velar+labbio-velar cluster are possible.

(2) Examples for table 5-2

/sp/	/spəháwts' / 'beautiful'	/sts' //sts' áhawnt/	'tree knot'
/st/	/stəkát/ 'onion'	/ʃtʃ/ /ʃtʃě/	'leader'
/st ^h /	/st ^h áhan' / 'soap'	/ʃtʃ ^h / /ʃtʃ ^h uwǎ/	'thigh'
/st' /	/st'wǎʔ/ 'sheep'	/ʃtʃ' //ʃtʃ' éʔ/	'tortilla plate'
/sk/	/skampǔ/ 'my fingernail'	/sm/ /smáwl/	'Carnero'
/sk ^h /	/sk ^h át's' / 'table tool'	/sn/ /snəgwěhəts' /	'his hat'
/sk' /	/sk'əʔén/ 'he returns to drag'	/ʃn/ /ʃnúʔu/	'good morning'
/sts/	/stsǎʔənt/ 'he returns to cut'	/ʃpj/ /ʃpjá/	'iron'
/sts ^h /	/sts ^h áwʔ/ 'ruler'	/skw/ /skwáʔant/	'clothing'

5.2.1. Onset complexity

The issue that is considered in this section is that of constrained onset complexity. While many languages around the world allow only simple onsets, other languages exhibit varying degrees of onset complexity. Northern Pame is a case in between two extremes. Complexity does exist, yet it is highly constrained in the combinations of segments that are allowed to cluster together.

The fact that some languages avoid any onset complexity whatsoever suggests a

constraint prohibition as in the following.

- (3) *COMPLEX-O (Prince and Smolensky 1993)

‘Complex onsets are prohibited.’

Let us assume that *COMPLEX-O is relatively low ranked in Northern Pame so that, in general terms, the speaker has no intuitive inhibitions to these kinds of structures. In Optimality Theory, we can say that the output is faithful or *corresponds* to the input in a faithfulness constraint that maximizes the input to output correspondence (MAX-IO).

- (4) MAX-IO (Kager 1999)

‘Input segments have output correspondents’. No deletion.

The fact that *COMPLEX-O is not a productive constraint in Northern Pame onsets, while MAX-IO does apply gives evidence for a ranking where MAX-IO dominates *COMPLEX-O.

- (5) Ranking: Faithfulness dominates markedness

MAX-IO >> *COMPLEX-O

(6) Faithfulness outranks markedness

Input: /bjúʔ/	MAX-IO	*COMPLEX-O
a. búʔ	*!	
b. [☞] bjúʔ		*

(7) Faithfulness outranks markedness

Input: /n.k'wéʃ/	MAX-IO	*COMPLEX-O
a. n.k'éʃ	*!	
b. n.wéʃ	*!	
c. [☞] n.k'wéʃ		*

In (6-7), three examples are given with an input form that has a complex onset and which remains faithful in the phonetic form (i.e. 'output'). For example, in (6) the input has a complex cluster /bj/ which is evaluated by the constraint ranking MAX-IO >>*COMPLEX-O. Candidate (a) allows *COMPLEX to apply, but at the cost of higher ranked MAX-IO. Candidate (a), therefore, has a fatal violation. Candidate (b) is the opposite case. Here, *COMPLEX-O is violated, but the higher ranked MAX-IO is preserved. Hence, candidate (b) is the optimal candidate. The example in (7) exemplifies parallel argumentation, except with a syllabic /ŋ/ prefixed to the stem. In this case, the input includes an complex onset containing /kw/ which is evaluated by the constraint ranking forbidding complex onsets and input faithfulness. Once again, faithfulness to the

input prevails and no change in the output (such as deletion, for example) is invoked.

5.2.2. /*pw/ clusters

The ranking in (5) has a limitation in that it predicts attested and unattested Northern Pame onset clusters. In particular, let us first focus on the clusters of /*pw/. Clusters that involve contiguous labial articulations such as /*pw/ never occur in Northern Pame. Instead, Northern Pame data suggest that the labio-velar glide will delete resulting in a simple /p/ onset.

(8) Deletion of labio-velar glide

INPUT	OUTPUT	
/pwǣp/	[pǣp]	'he helps him'
/pwǣ/	[pǣ]	'he braids'
/mwéhu/	[mehu]	'he lives'
/mwúhu j/	[múhu j]	'he passes by'
/kwǎts/	[kwǎts]	'he sets.soft'
/ʔwétʂ' /	[ʔwétʂ']	'he writes'
/hwětʂ/	[hwětʂ]	'he hunts'

The data in (8) are examples of morphologically complex words where the prefix/w/ '3rd

person subject' is attached to the root. The subject morpheme surfaces in non-bilabial contexts as illustrated in the examples containing a root beginning with a velar or a laryngeal consonant (i.e. /kw//ʔw//hw/). However, if the input contains a combination of /pw/, /w/ is not permitted to surface so that we only have the bilabial root consonant.

(9) Example of glide deletion

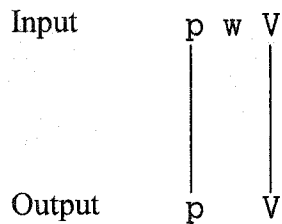

Example (9) is a prototypical illustration of underlying representations for any bilabial+/w/ onset clusters. The grammar of Northern Pame blocks the surfacing of /w/ via deletion, but unfortunately, we see that the ranking in (5) will not predict such a deletion. This is shown in the following tableau.³²

(10) MAX-/w/

'Labial segments in the input will have output correspondents.'

³² Here, a specific MAX constraint, MAX-/w/ is invoked since bilabials alone make up this process.

(11) Labio-velar glide incorrectly surfaces

Input:	/pwæ/	MAX-/w/	*COMPLEX-O
a.	pæ	*!	
b. ☹	pwæ		*

The reason that (5) does not select the correct candidate in (11) is that the issue is not one of onset complexity, but of adjacent labial features. The fact that the output is a non-complex onset is purely accidental. Rather, this fact is better accounted for by the Obligatory Contour Principal or ‘OCP’ (Goldsmith 1990), a family of closely related principles that prohibits adjacent segments, autosegments or suprasegments. In Northern Pame, adjacent segments that are labial (among others) are prohibited based on the OCP.

(12) OCP (Leben 1973, Goldsmith 1979, Odden 1988)

‘Adjacent segments are prohibited’

By adding an OCP constraint prohibiting contiguous labials we have limited the licensed candidates that will partake in complex onsets. In (13), this is seen via the adapted ranking scheme.

(13) Ranking: OCP dominates faithfulness

OCP >> MAX-IO >> *COMPLEX-O

Now, let us consider how the OCP will check faithfulness in Northern Pame onsets with contiguous features for [+labial].

(14) OCP checks faithfulness

Input: /pwæ/	OCP	MAX-/w/	*COMPLEX-O
a. $\text{p}^{\text{h}}\text{æ}$		*	
b. $\text{pw}^{\text{h}}\text{æ}$	*!		*

In (14), the input has a complex onset cluster made up of two contiguous labial consonants. The faithful candidate (b) is automatically ruled out because it violates high ranking OCP. Candidate (a) on the other hand, sacrifices the segmental faithfulness of the labio-velar glide and the OCP constraint is subsequently preserved. Hence, candidate (a) is the winner, which agrees with the surface facts of the language.

5.2.3. /*tj/ clusters

Similar data to the described above exist where an onset contains a coronal or velar consonant followed by a palatal glide. In every case, the output of such combinations results in a coalescence of the two consonants into a palatalized form.

(15) Coalescence of palatal glide

Input	Output	
/k'ətjuwémp/	[k'ətʃuwémp]	'you break it on him'
/nətjú/	[nətʃú]	'you killed'
/k'ətsjuwæn/	[k'ətʃuwæn]	'you are angry'
/nətsjéʔ/	[nətʃíʔ]	'you took it'
/mɑ nʔljún/	[mɑ nʔʌún]	'they will care'
/nəʔl ^h júmp/	[nəʔʌ ^h úmp]	'you were calm'
/k'əkjět/	[k'ətʃět]	'you defend yourself'
/k'əkjén/	[k'ətʃén]	'you drag'
/nəkjúp/	[nətʃúp]	'you rejected'
/pjáʔɑ/	[pjáʔɑ]	'tomorrow'
/mjáhaw/	[mjáhaw]	'his stomach'
/bjuʔ/	[bjuʔ]	'def.art.inanim.'
/k'əsjáwʔ/	[k'əʃáwʔ]	'you teach'

The data in (15) illustrate circumstances where the input contains a consonant followed by a palatal glide either morphologically or lexically. Morphological examples include the subject marker for 'you', 'they' as well as the possessor morpheme for 'his, her'. Looking at

the optimal output candidates in (15), we see that the only surface forms to contain the palatal glide are those where the preceding consonant is a bilabial, while coronal and velar consonants do not. In the latter case, the optimal surface candidate contains a coalesced alveo-palatal form.

(16) Example of glide coalescence

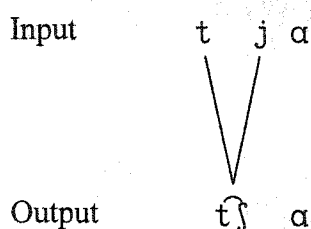

Example (16) illustrates the process of coalescence as a combination of two segments into one. In Optimality Theory terms, coalescence is described as a violation of segment faithfulness to UNIF-IO.

(17) UNIFORMITY-IO (UNIF-IO) (McCarthy and Prince 1995)

‘Output segments must not have multiple input correspondents’.

Analogous to the ranking MAX-IO >> *COMPLEX-O, we might rank UNIF-IO above *COMPLEX-O. That is, let faithfulness be undominated by any markedness constraint. However, as (18) illustrates, this has the same dire effects as /pw/ in allowing unattested clusters such as /kj/ to surface.

(18) Palatal glide incorrectly surfaces

Input: /k'əkjět/	UNIF-IO	*COMPLEX-O
a. $\textcircled{\otimes}$ k'əkjět		*
b. k'ətʃět	*!	

In (18), the input /k'əkjět/ is compared to the constraint ranking of UNIF-IO >> *COMPLEX-O. Candidate (b) loses since it fatally violates undominated UNIF-IO. Candidate (a) incorrectly wins as an effort to preserve segmental UNIF-IO. The problem is that the language facts always prefer (b), thus the ranking in (17) is incomplete. Analogous to the case of adjacent bilabials there must be another constraint other than onset complexity that is driving UNIF-IO to be violated. The constraints prohibiting adjacent articulations for either coronality or dorsality are summed up in the two variations of the OCP constraint defined in (19) and (20).³³

(19) OCP(Dor)

'Adjacent dorsal segments are prohibited'

(20) OCP(Cor)

'Adjacent coronal segments are prohibited'

Let us assume that the OCP dominates UNIF-IO so that the latter must be violated to

³³ The palatal glide, perhaps palatals in general, must be interpreted as both dorsal and coronal in order to invoke an OCP violation (Halle and Clements 1983).

preserve former.

(21) Ranking: OCP dominates faithfulness

OCP >> UNIF-IO

This ranking is demonstrated in the following tableaux.

(22) Coalescence of coronal consonants

Input:	/nətjǔ/	OCP	UNIF-IO
a.	nətjǔ	*!	
b. ☞	nətʃǔ		*

(23) Coalescence of dorsal consonants

Input:	/k'əkjǝt/	OCP	UNIF-IO
a.	k'əkjǝt	*!	
b. ☞	k'ətʃǝt		*

The inputs in (22) and (23) show a coronal or a velar consonant respectively followed by a palatal glide. In both cases, the faithful candidates (a) fatally violate an OCP constraint, while candidates (b) violate UNIF-IO, but preserve the OCP. Candidates (b) are correct with the language facts, thus supporting the ranking in (20).

5.2.4. *Deletion versus coalescence*

The discussion thus far has set up two mutually exclusive constraint conflicts where OCP is ranked relative to MAX-/w/ and UNIF-IO. However, why are the opposite scenarios not possible where contiguous bilabials might be coalesced or a palatal glide deleted? The answer must be that MAX-/w/ is ranked below UNIF-IO, so that if the input contains /w/, it will delete. Otherwise, coalescence is the best choice.

Adjusting the ranking of MAX-/w/ and UNIF-IO alone will not account for deletion of /w/ and coalescence of /j/. Example (24) illustrates the two possibilities.

- (24) Two ranking possibilities for faithfulness
- a. OCP >> MAX-/w/ >> UNIF-IO
 - b. OCP >> UNIF-IO >> MAX-/w/

If (24a) is assumed, the correct candidate (25a) will not win.

- (25) MAX-/w/ >> UNIF-IO

Input:	/pwæ/	OCP	MAX-/w/	UNIF-IO
a.	pwæ	*!		
b.	pæ		*!	
c. ☹	p ^w æ			*

The reason for the failure of deletion (25a) to win is because the constraint ranking is such

that coalescence, via a violation of UNIF-IO, is a less expensive way to preserve the OCP. That is, (24a) says that if there is a choice between coalescence or /w/ deletion, choose the former. Now, let us reverse the ranking in (26) to correspond with (23b).

(26) UNIF-IO >> MAX-/w/

Input: /pwæ/	OCP	UNIF-IO	MAX-/w/
a. pwæ	*!		
b. [☞] pæ			*
c. p ^w æ		*!	

As expected, /w/ deletion is now preferred to coalescence, which gives us the correct surface form.

Regarding palatalization with non-labials, we see that the ranking in (23b) will predict a post-alveolar affricate in (27), which is the correct form.

(27) UNIF-IO >> MAX-/w/

Input: /k'əkjět/	OCP	UNIF-IO	MAX-/w/
a. k'əkjět	*!		
b. [☞] k'ətʃjět		*!	

Likewise, if we reverse the ranking such as (23a) the correct form will still surface.

(28) MAX-/w/ >> UNIF-IO

Input:	/k'əkjət/	OCP	MAX-/w/	UNIF-IO
a.	k'əkjət	*!		
b.	k'ətʃət			*

In other words, with the constraint MAX-/w/ only at risk in the case of a /w/ on a consonant cluster, we need only to keep MAX-/w/ ranked below UNIF-IO in order to avoid choosing a coalesced labial consonant as the winner. The final ranking is giving below.

(29) Final ranking of faithfulness on onsets.

OCP >> UNIF-IO >> MAX-/w/

5.3. Nuclei

Lexical morphemes may be either monosyllabic or bisyllabic in line with the following data.

TABLE 5-3. Possible nuclei in lexical morphemes

TYPE	NUCLEI	EXAMPLE	
a. V	/u/	/gətũ/	'a kind of nut'
b. uwV	/uwa/	/səʔnũwã/	'my nose'
c. VhV	/æhæ/	/pæhæ/	'he carries'
d. VʔV	/æʔæ/	/nt ^h æʔæ/	'tamale'

Any vowel is possible in monosyllabic forms, while bisyllabic morphemes are limited to the type where: 1) /u/ is epenthesized between the onset and a labio-velar glide, or 2) a vowel unspecified for quality is epenthesized between the onset and a laryngeal consonant (see chapter 4). In other words, these two types of epenthesis occur when ill-formed onset clusters are present in the input.

Northern Pame eschews the notion of complex nuclei. In no instance may unambiguous vowels cluster together in combinations such as /eæ/, /æe/, /ɑæ/, or /eɑ/. In addition, the combination of a non-high vowel and a high-vowel is syllabified by Northern Pame speakers as a monosyllabic glide+vowel or vice versa, a fact which is supported by the interaction of glides with onsets as well as with codas (see below). Thus, there is clear support for ranking a context-free markedness constraint prohibiting complex nuclei above faithfulness to complex nuclei inputs.

(30) *COMPLEX-N (Prince and Smolensky 1993)

‘Complex nuclei are prohibited’.

(31) Markedness dominates faithfulness

*COMPLEX-N >> MAX-IO

As illustrated in table 5-3, when illicit onsets are in the input, the language prefers vowel

epenthesis as the means of respecting onset phonotactics. Optimality Theory considers epenthesis a violation of the faithfulness constraint ‘dependency’ (Kager 1999: 68).

(32) DEPENDENCY (DEP-IO) (McCarthy and Prince 1995)

‘Output segments must have input correspondents’.

Dependency must be ranked below context-free phonotactic constraints³⁴.

(33) Ranking: Markedness dominates faithfulness

*Any phonotactic constraint >> DEP-IO

Let us see how epenthesis is motivated via this ranking.

(34) Epenthesis splitting up illicit /nw/ clusters

Input:	/səʔnwǎ/	/*nw/	MAX-IO	DEP-IO
a.	səʔnwǎ	*!		
b.	səʔnǎ		*!	
c. \mathcal{F}	səʔnǎwǎ			*

In (34), the underlying form for ‘my nose’ contains the prohibited onset cluster /nw/.

³⁴ That is, any phonotactic combinations that are prohibited. The individual phonotactic constraint is illustrated in the tableau that it pertains to.

Candidate (a) is the totally faithful form, which fails because it fatally violates the high ranking phonotactic constraint /*nw/. Candidate (b) attempts to preserve phonotactics by consonant deletion (i.e. a violation of MAX-IO). However, this also fails since there is yet another faithfulness constraint to be violated at a lesser cost, which is DEP-IO. The violation of DEP-IO in the surface form of epenthesis will both preserve onset phonotactics and MAX-IO. Thus, by using the epenthesis candidate, (c) is the winner. Examples (37) and (38) illustrate the same process for consonant+laryngeal onsets.

(35) Epenthesis splitting up illicit /Ch/ clusters

Input:	/phæ/	/*Ch/	MAX-IO	DEP-IO
a.	phæ	*!		
b.	pæ		*!	
c. 	pæhæ			*

(36) Epenthesis splitting up illicit /Cʔ/ clusters

Input:	/nt ^h ʔæ/	/*Cʔ/	MAX-IO	DEP-IO
a.	nt ^h ʔæ	*!		
b.	nt ^h æ		*!	
c. 	nt ^h æʔæ			*

5.3.1. *Nasal vowels*

Northern Pame has a phonemic contrast for nasalization of its vowels as in the following data.

(37) Oral-nasal vowel contrasts

ORAL VOWEL		NASAL VOWEL	
/bəsǎ/	'corn.pl.'	/bəsǎ̃/	'itch'
/nt'ūs/	'house'	/nʔt ^h ūs̃/	'my salt'
/nt ^h új/	'woman'	/nt ^h új̃/	'hunger'
/nt ^h ǎ̃ʔǎ̃/	'influenza'	/nt ^h ǎ̃ʔǎ̃̃/	'tamale'
/dəʔwát̃̃/	'he kicked'	/lkǎ̃t̃̃s/	'I set.soft'

Notice that the contrasts represented in (37) cover several different environments including open and closed syllables. Also, bisyllabic roots can also be contrastively nasalized. Thus, the data clearly indicate that [nasal] is a contrastive feature regardless of the presence or absence of a coda and regardless of an intervening laryngeal.

Nasal vowel contrasts are not universal among the world's languages, but rather are the exception. Therefore, a universal constraint prohibiting nasal vowels has cross-linguistic motivation.

(38) * \tilde{V} (Kager 1999)

‘Nasal vowels are prohibited’.

Since * \tilde{V} is violated in Northern Pame, there must be a faithfulness constraint present that dominates it. Such a constraint comes from the ‘Identity’ family which corresponds to a particular feature in question; in this case, the feature [nasal].

(39) IDENTITY[nas] (IDENT[nas])

‘Output segments have input correspondents for the feature [nasal].’

IDENT[nas] will refer to the feature [nasal] and its corresponding value [+/-]. Thus, IDENT[nas] is preserved as long as the value remains the same in the input to the output. Obviously, IDENT[nas] must dominate * \tilde{V} in the ranking of Northern Pame in order to allow underlyingly nasal vowels to surface.

(40) High ranking of nasal faithfulness

IDENT[nas]>> * \tilde{V}

This ranking will allow vowels that are underlyingly nasal to always surface with the same nasal specification, just as oral vowels will always remain [-nasal].

(41) Faithfulness of nasal vowels

Input: /bəsã/	IDENT: V[nasal]	* \tilde{V}
a. bəsã	*!	
b. bəsã̃		*

For example, in (41) the input has a word with a nasal vowel. Comparing this form to the ranking in (40), we see there are two possible candidates with regard to the prohibition of nasal vowels. Candidate (a) is the attempt to preserve a nasal vowel prohibition, but this comes at a cost of the higher ranking faithfulness constraint. Candidate (b) preserves the input [nasal] feature and is the winner.

5.3.2. Denasalization

The fact that Northern Pame has contrastive oral and nasal vowels has interesting consequences when such vowels precede nasal consonant codas. Consider the possibilities for a nucleus and a coda with regard to the feature [nasal].

TABLE 5-4. VC [nasal] possibilities for nucleus+coda

		CONSONANT	
		[-nasal]	[+nasal]
VOWEL	[-nasal]	VC	VN
	[+nasal]	$\tilde{V}C$	$\tilde{V}N$

Oral or nasal vowels may be followed by oral consonants as previously illustrated in (37).

Likewise, nasal vowels may be followed by nasal consonants as in the following.

- (42) Nasal vowel+nasal consonant
- | | |
|---------------------------|------------------|
| /rhĩn/ | 'grandfather' |
| /sĩn/ | 'he opens' |
| /m ^h jě̃n/ | 'soup' |
| /mǎ̃n/ | 'he wants' |
| /nǎ̃wnt/ | 'eat it!' |
| /lɛ̃ʔně̃nt/ | 'he tightens' |
| /lɛ̃ʔhwǎ̃nt̃s/ | 'he lifts.heavy' |
| /nt̃jě̃mp/ | 'river' |
| /lɛ̃ʔl ^h ũ̃mp/ | 'he is calm' |

However, when an oral vowel is followed by a nasal consonant, the latter is denasalized to a prestopped nasal (Berthiaume 2000). A prestopped nasal is phonetically identical to a homorganic voiced stop+nasal cluster.

(43) Oral vowel+nasal consonant

/ʌǔmp/ [ʌǔb̃mp] 'his chicken'

/gutémp/ [yutéb̃mp] 'my lion'

/mʔínt/ [mʔíd̃nt] 'heavy'

/ntsénʔ/ [ntséd̃nʔ] 'not here'

/tsuwæn/ [tsuwæg̃ŋ] 'he is angry'

/gutén/ [yutéǵ̃ŋ] 'lion'

The facts that support that these stopped nasals are indeed underlyingly plain nasal consonants and not consonant clusters are considerable. First, Northern Pame prohibits voiced stops in syllable codas. Hence, if the voiced stops in prestopped nasals really are separate segments plus a nasal consonant, this is a strange exception. Second, the place of articulation of these stops always pattern with the nasal, not vice versa. For example, Northern Pame nasals always neutralize to velar nasals in simple codas (see below in 'codas'). If a (voiceless) stop should follow, the nasal place of articulation assimilates to that of the stop. The same process is at work regardless if the nasal is prestopped or not. If these were sequences of phonemes, this simple assimilation process would be complicated since the place assimilation process would have to apply to both a nasal and a voiced stop. Finally, prestopped nasals only occur after oral vowels, while plain nasals are restricted to post-nasal vowel environments. This symmetry is left unexplained if these are clusters of a stop plus a nasal.

Let us first ask why it is that an oral vowel preceding a nasal consonant might be problematic. In articulatory terms, it is quite common for languages to actually nasalize such vowels in a process of anticipatory velum lowering (Ohala 1975). During the articulation of the vowel, the velum will be lowered in anticipation of the production of the nasal consonant. English is just one of many examples of a language with this process.

(44) Nasalization of English vowels

[sɛ̃nd] 'send'

[sæ̃ŋ] 'sang'

[sɛ̃m] 'some'

The tendency for languages to nasalize vowels before nasal codas is motivated by the following markedness constraint.

(45) *VN (Kager 1999)

‘Oral vowels are prohibited before nasal consonants’.

In the English case, the constraint *VN is ranked above the vowel’s value for [nasal].

(46) Markedness dominates faithfulness

*VN >> IDENT:V[nasal]

(47) Vowel nasal assimilation in English

Input:	/sæŋ/	*VN	IDENT:V[nasal]
a.	sæŋ	*!	
b.	sæ̃ŋ		*

In (47), faithfulness to vowel [nasal] (that being [-nasal]) in the input is sacrificed in order to allow *VN to apply. That is, anticipatory velum lowering occurs.

Parallel to English, Northern Pame also prohibits oral vowels to distribute before nasal consonants. That is, *VN is still in effect. However, as a means to preserve *VN English chooses to violate *vowel* [nasal] faithfulness, the phonology of Northern Pame has chosen to sacrifice the [nasal] faithfulness of the following *consonant*. The reason for this disparity can be explained by the fact that unlike English, Northern Pame has contrastive nasalization for its vowels. If Northern Pame were to have a process of anticipatory velum as does English, the oral/nasal contrast would always be neutralized before nasal consonants. Thus, Northern Pame phonology has sought another means of accommodating *VN while preserving optimal vowel contrasts.

Compare the two systems of English and Northern Pame with reference to vowel and consonant specifications for [nasal].

(48) English ranking of anticipatory nasalization.

*VN >> IDENT:C[nasal] >> IDENT:V[nasal]

(49) Northern Pame ranking of denasalization.

*VN >> IDENT:V[nasal] >> IDENT:C[nasal]

The difference between the two is the relative order of IDENT:V[nasal] and IDENT:C[nasal]. English has IDENT:V[nasal] ranked lower than IDENT:C[nasal] and hence, it is the most violable. On the other hand, Northern Pame has the two Identity constraints reversed and therefore, will denasalize the consonant via a violation of IDENT:C[nasal].

(50) Anticipatory velum lowering in English.

Input:	/sæŋ/	*VN	IDENT:C[nasal]	IDENT:V[nasal]
a.	sæŋ	*!		
b. 	sæ̃ŋ			*
c.	sæŋ̆		*!	

(51) Delayed velum lowering in Northern Pame

Input:	/talún/	*VN	IDENT:V[nasal]	IDENT:C[nasal]
a.	talún̄	*!		
b.	talún̄̃		*!	
c. ☞	talúŋ̃			*

In (50) and (51), *VN is preserved at the expense of featural faithfulness. Three types of candidates are suggested. The completely faithful one (a), a nasalized vowel (b), or a denasalized coda (c). Notice that candidate (a) does not win in either case due to the high rank of *VN. In (52), the lowest ranked constraint in question is vocalic nasal faithfulness and thus (b) is the winner. In contrast, (53) has consonant [nasal] faithfulness as the least ranked constraint, which motivates (c) as the winning candidate. Crucially, the difference between the two languages is captured by the different constraint rankings.

Finally, consider the Northern Pame case where *VN is not vulnerable to violation because the input is already well-formed. In such a case, markedness *and* faithfulness should be preserved.

(52) Complete segmental nasal faithfulness

Input: /má̃n/	*VN	IDENT:V[nasal]	IDENT:C[nasal]
a. má̃ŋ			
b. má̃ŋ		*!	
c. má̃ŋ̃			*

In (52), the input has a nasal vowel followed by a nasal consonant. Crucially, this time the totally faithful candidate wins since *VN is not applicable. Therefore, the winning candidate (a) is the one with no violations at all.

5.4. Codas

Northern Pame lexical roots allow for considerable coda complexity. Northern Pame codas are limited to voiceless obstruents or any sonorant with the exception of /h/ and /r/. The only obstruents that may cluster together are affricates, fricatives or glottal stop followed by a voiceless stop.

TABLE 5-5. Northern Pame codas

C	All consonants (except voiced obstruents, flaps and /h/)			
CC	/sp/	/sk/	/sk' /	
	/[m]p/	/[n]t/	/[ŋ]k/	/[ŋ]k' /
	/lp/	/lt/	/lk/	/lk' /

	/ʎp/	/wt/	/ʎk/	/ʎk' /
	/jp/	/ʔt/	/wk/	/wk' /
	/ʔp/	/ʔs /ʔʃ/	/jk/	/jk' /
			/ʔk/	/nʔ/
			/ws/	/wʔ/
				/jʔ/
CCC	/wʔs/			/wnʔ/
	/ʔsp/, /ʔʃp/		/ʔsk/, /ʔʃk/	
CCCC	/wʔsk			

(53) Examples for complex C's in table 5-5

/ʔsp/	np ^h æʔsp	'his lily'	/ʎk' /	hwíwʎk	'he places you'
/ʔsk/	np ^h æʔsk	'my lily'	/ʎp/	gusáʎp	'his eagle'
/sp/	nənʔhásp	'I began'	/ʎk/	gusáʎk	'my eagle'
/sk/	ləʔn ^h ásk	'he began'	/ʎk' /	gusáʎk'	'your eagle'
/sk' /	təʔn ^h ásk	'I began'	/wt/	tʃáhawt	'you hold it'
/mp/	tuwémp	'it breaks on him'	/wk/	səhéwk	'I thank myself'
/nt/	pəhənt	'he takes them'	/wk' /	səhéwk'	'thank you'
/ŋk/	ʎúŋk	'my chicken'	/jp/	kən ^h jújp	'inside'
/ŋk' /	ʎúŋk'	'your chicken'	/jk/	dəntʃájk	'my small squash'

/lp/	hwíwlp	'he places him'	/jk' /	dəntʃájk'	'your small squash'
/lk/	hwíwlk	'he places me'	/ʔk/	sáʔk	'he trims for me'
/nʔ/	nt̃sénʔ	'not here'	/ʔk' /	sáʔk'	'he trims for you'
/wʔs/	ma nʔdewts'	'he will write'	/ʔp/	sáʔp	'he trims for him'
/ws/	kənhwáws	'sweet drink'	/wʔ/	sáwʔ	'he teaches'
/wnʔ/	něwnʔ	'he said'	/jʔ/	ʃeʔjuʔjʔ	'polio'

5.4.1. Nasal place assimilation

Modal voice nasal consonants lose their specification for place in complex codas. If the nasal coda is simple, it will surface as a velar nasal allophone.

(54) Nasal codas (word final)

/rhín/	[rhín]	'grandfather'
/sín/	[sín]	'he opens'
/m ^h jén/	[m ^h jén]	'soup'
/mán/	[mán]	'he wants'
/nāwn/	[nāwn]	'he eats'
/t̃suwæn/	[t̃suwæg̃n]	'he is angry'
/gutén/	[ɣutég̃n]	'lion'

/táwn/	[táwŋ̃]	'he buys'
/mǔn/	[mǔŋ̃]	'it is born'
/séhen/	[séhəŋ̃]	'he dines'
/ʎǔmp/	[ʎǔb̃mp]	'his chicken'
/mʔicnt/	[mʔíɗ̃nt]	'heavy'

As noted earlier, should a simple nasal coda follow an oral vowel, the nasal will be prestopped (see 'denasalization' above). Moreover, if the nasal coda is followed by a stop, the only consonant that can follow a nasal coda, the nasal will assimilate to the place specification of the following stop.

Below are additional data of nasal codas in word medial position. Notice that the nasal coda assimilates to the place specification of the following onset consonant³⁵ (Itô 1989: 224-25), a common process for nasals in consonant clusters.

(55) Nasal codas (word medial)

[mp]	[skəmpǔ]	'your finger nail'
[mp]	[gəmpjú]	'cohete'
[mb]	[ʎǔmbət]	'his chickens'

³⁵ Voiced velar stop onsets never occur in word medial clusters in Northern Pame.

[mb]	[təʔl ^h úmbe]	'we.Dl. are calm'
[nt]	[kəntæ]	'water'
[nt']	[sənt'áj]	'hand'
[nd]	[ʔúndət]	'my chickens'
[nd]	[k'ənděwdn']	'you are about to say'
[ŋk]	[ma ŋʔkasáwʔ]	'you will learn'
[ŋk]	[ma ŋʔkəráhaw]	'you will speak'

The fact that Northern Pame nasal codas lack place specifications is analogous to many languages around the world. The explanation for this is summed up in the Coda Condition, which is a constraint prohibiting place on syllable codas (Goldsmith 1990, Itô 1989). In these types of systems, nasal codas acquire surface place articulation by the following consonant in word medial clusters. Word finally, the Coda Condition is either violated or the place of articulation is acquired in some type of post-lexical process.

(56) CODA-COND (Fudge 1969, Selkirk 1982, Itô 1989)

'Independent place features are prohibited in codas'

The data facts for Northern Pame show that the Coda Condition does not apply across the board. As the data in tables 5-5 and 5-6 illustrate, obstruents license place in syllable

codas. However, leaving the exception of coda obstruents aside let us examine nasal codas only in this section.

Looking at the word medial examples first, we see that nasals assimilate to the place of a following stop, and moreover, the stop is an onset of the following syllable. Such a process can be interpreted as a violation of nasal place (IDENT (Place) precipitated by the Coda Condition.³⁶

(57) IDENT(Place) (McCarthy and Prince 1995)

‘Output segments have input correspondents for Place’

(58) Markedness dominates faithfulness

CODA-COND >> IDENT(Place)

(59) Nasal place assimilation (word medial)

Input: /skənpǔ/	CODA-COND	IDENT(Place)
a. skənpǔ	*!	
b. skəmpǔ		*

By applying the constraint ranking in (58), we see some possible candidates in (59).

Candidate (a) is the faithful one, where the nasal preserves its place specification while in a

³⁶ Nasal codas always agree in place to a following stop if there is one. In cases where the nasal is a simple coda (i.e. word finally), it always surfaces as a non-phonemic velar nasal as described in the following section. Nasal (placeless) codas are represented with the alveolar nasal /n/ phoneme in underlying form for notational purposes only

syllable coda. This has the fatal effect of violating CODA-COND. Candidate (b) takes the opposite approach of violating the place specification of the nasal, thus allowing CODA-COND to apply. Thus, (b) is the winner. The same strategy works for word final nasals followed by a stop.

(60) Nasal place assimilation (word final)

Input:	/ʎũnp/	CODA-COND	IDENT(Place)
a.	ʎũnp	*!	
b. ^σ	ʎũmp		*

5.4.2. Nasal velarization

Looking again at the examples in (54) notice that a simple nasal coda surfaces as a velar allophone. Why is a velar chosen instead of a coronal or perhaps deletion or epenthesis? This topic has been discussed in Goldsmith (1990), and Hyman (1975) and particularly in Paradis and Prunet (1993), who claim that velar place of articulation has phonological support as the default for nasal codas.

Paradis and Prunet examine nasal coda velarization in three dialects of Uradhi in light of the claim of a universal default articulator (i.e. coronal). The authors ask under what circumstances might universal grammar choose a dorsal place rather than a coronal articulator for nasal consonants saying, “Angma sometimes behaves as if its velar articulation were absent from underlying representation (UR) or as if it were the weakest of all nasal consonants” (426). Paradis and Prunet mention that it is quite common for word/phrase final

nasals to surface as velar in languages such as those of the Manding family (Creissels 1989), Selayarese (Goldsmith 1990) and Japanese (Yip 1991). The authors' basic answer to the fact that word/phrase final nasals are often velar rather than coronal is that dorsal place assimilation must be explained as a spreading process of place from the previous vowel (426).

(61) Dorsal assimilation from previous vowel (Paradis and Prunet 1993)

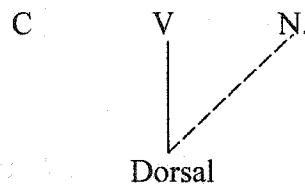

Paradis and Prunet offer three possible questions concerning their analysis (433):

- a. Do all vowels have a Dorsal articulator in UR and/or at the surface?
- b. Why do the dorsal dependent vowel features not color the velar nasal?
- c. Since vowels can have other articulators, can these other articulators ever spread?

Regarding (a), the authors discuss the claim of a vocalic coronal articulator (Clements 1993, Lahiri and Evers 1991), but counter that such a view always assumes a dorsal articulator in addition to a coronal one. In addition, velarization of final nasals is often a post-lexical process, which assumes a fully specified previous vowel, both for coronal and dorsal nodes. In addition, the authors cite Shaw (1991: 129) who notes that while coronal and labial

consonant harmony systems are widely attested, there are few or no known dorsal consonant ones. This would make sense if we assume that the intervening vowels always have a specified dorsal node. Regarding (b), Paradis and Prunet mention that the dorsal articulator spreads with its dependent features, but that these may be subsequently severed from the velar consonant either because the information they encode is not contrastive in the small articulatory range occupied by velar nasals or because they create an ill-formed consonant (434). For (c), the authors cite examples from Fula, French, and Japanese that show that indeed, other vocalic articulators can spread to consonants giving us the implication that dorsal spreading although productive, is not necessarily universal.

Returning to the Northern Pame question, it was shown above that nasal codas are forbidden to surface with an independent place setting in medial clusters and as velar allophones in simple final codas. The claim made here is that the process velar assimilation to the previous vowel is invoked to provide these placeless nasals with the means to be fully articulated on the surface. Assuming that all vowels are specified with the dorsal node (-/+back) with or without the coronal or labial node, the dorsal node is always available to be linked to Northern Pame final nasals. Additionally, this approach makes sense in light of the fact that final (velar) nasals are allophonic in Northern Pame therefore, post-lexical in parallel with the cases cited by Paradis and Prunet.

By way of explanation, we must specify the markedness constraint prohibiting coronal place and the faithfulness constraint for vowel dorsal articulation.

(62) *[cor] (Prince and Smolensky 1993)

‘Coronal place is prohibited’

(63) IDENT:V(Dor) (McCarthy and Prince 1995)

‘Output vocoids have input correspondents for (Dor)’

*[cor] and IDENT:V(Dor) need not be ranked relative to one another, since the higher ranked CODA-COND will guarantee that final nasals will not have independent place specification.³⁷ Note that the claim that *[cor] is universally dominated by other place nodes (Prince Smolensky (1993), Kager 1999) is not an issue here, since *[dor] would surface if there was not a preceding vowel. Thus, the distinction is made here between *[dor] and IDENT:V(Dor).

(64) Ranking for nasal velarization.

CODA-COND >> *[cor], IDENT:V(Dor)

The result will be that vocalic dorsal assimilation will be forced to operate.

³⁷ However, IDENT:V(Cor) must dominate IDENT:V(Dor). For simplicity, this ranking is assumed in the tableau.

(65) Dorsalization of simple nasal codas

Input: /sín/	CODA-COND	*[cor]	IDENT:V(Dor)
a. sín	*!	*	
b. sɪŋ			*

In (65), the Coda Condition filters out any attempt at attaching an independent place articulation for a word final nasal. However, the dorsal node of the vowel is available regardless of its specification for backness. The nasal links its place node parasitically to that of the previous vowel so that full specification is acquired in the output form. Thus, candidate (b) is the most optimal since the Coda Condition is preserved.

5.4.3. Devoicing of Stop codas

Northern Pame does not allow for voiced stops in coda position, but only voiceless.

(66) Word final obstruent devoicing

/nmæʔæp/ 'donkey'

/mjæʔæbət/ 'donkeys'

/lɛʔtʃǝt/ 'he defends himself'

/lɛʔtʃǝdət/ 'they defend themselves'

/ʃtʃǝk/ 'my superior'

/ʃtʃǝgət/ 'my superiors'

However, it is always the case that when word final stops are found intervocalically due to suffixation, a voiced stop will surface. Thus, there exists a question as to whether or not

these are underlyingly voiced or voiceless segments. That is, is it more accurate to describe the alternations in (66) as one of intervocalic voicing of voiceless stops or as coda devoicing of voiced stops? In the following data, we see analogous intervocalic contrasts for voiceless and voiced stops. On the other hand, there is no data in Northern Pame that has a voiceless stop word finally, which upon suffixation of a /-V(C)/ morpheme remains voiceless. Therefore, the data in (67) give clear evidence that only a coda devoicing interpretation is tenable.

(67) Intervocalic voicing contrasts

/dɛpɑ́j/	'tomato'
/stɛbɛ́w/	'shawl'
/kɛtɑ́/	'water hole'
/gɛdɛ́w/	'youth'
/dɛkúp/	'he rejected him'
/pɑgɑ́s/	'cow'

Northern Pame voiceless and voiced consonants contrast intervocalically, while voicing neutralizes to voicelessness word finally. Such circumstances motivate the following constraint.

(68) *CODA-VceObs (Kager 1999)

‘Voiced obstruents are prohibited in codas’

Coda devoicing can be straightforwardly accounted for by ranking markedness above voicing faithfulness.

(69) Markedness dominates faithfulness

*CODA-VceObs >> IDENT[vce]

Assuming an input with a voiced coda, the optimal candidate will always be voiceless.

Should the segment be in a non-coda environment, voicing faithfulness will surface.

(70) Devoicing of voiced coda

Input: /nmæʔæb/	CODA-VceObs	IDENT[vce]
a. nmæʔæb	*!	
b. [☞] nmæʔæp		*

In (70), the input has a voiced obstruent in word final coda position. The faithful candidate (a) loses due to high ranking CODA-VceObs. Candidate (b) satisfies CODA-VceObs while violating faithfulness for [vce], which compared to (a) is a better fit. Candidate (b) is therefore the winner.

5.4.4. Intrusive stop formation

Underlying clusters of /ʔs/ are forbidden to surface in Northern Pame in word final position. In these cases, /s/ always surfaces as /t̂s/ in a process of intrusive stop formation (Clements 1987, Piggot and Singh 1985, Wetzels 1985, Barnitz 1974). The following forms illustrate this.

- (71) Intrusive /t/ between /ʔs/
- | | | |
|-----------------------|-------------------------|--------|
| /np ^h ǎʔs/ | [np ^h ǎʔt̂s] | 'lily' |
| /ʃkiʔpjǎʔs/ | [ʃkəʔpjǎʔt̂s] | 'toad' |

Both 'lily' and 'toad' have underlying forms that end in a cluster of /ʔs/, but their surface forms demand that an intervening stop consonant exist. This prohibition against such clusters is nullified if these segments are followed by something other than a pause, such as the forms below in (72). In these cases, the possessor suffixed 'my' and alternately, 'his' is present before which the cluster /ʔs/ remains unepenthesized in the surface form.

- (72)
- | | | |
|------------------------|------------------------|------------|
| /np ^h ǎʔsk/ | [np ^h ǎʔsk] | 'my lily' |
| /ʃkiʔpjǎʔsk/ | [ʃkiʔpjǎʔsk] | 'my toad' |
| /np ^h ǎʔsp/ | [np ^h ǎʔsp] | 'his lily' |

/ʃkiʔpjæ'sp/

[ʃkiʔpjætʰs'p]

'his toad'

In order to account for intrusive stop formation in final /ʔs/ clusters, let us first define the phonotactic constraint that is at work.

(73) *GLOTT-S#

'A phonotactic constraint prohibiting word final clusters containing /ʔs/ or /ʔʃ/.'

The constraint *GLOTT-S# must dominate DEP-IO forcing epenthesis to occur in the optimal surface candidate.

(74) Violation of DEP-IO wins

Input: /np ^h æʔs/	*GLOTT-S#	DEP-IO
a. np ^h æʔs	*!	
b.  np ^h æʔts		*

In (74), the input /np^hæʔs/ 'lily' has a word final cluster of glottal stop plus an alveolar fricative. Candidate (a) makes no change to this form and in so doing, fatally violates *GLOTT-S# Candidate (b) preserves *GLOTT-S# by violating DEP-IO 'no epenthesis' therefore providing the necessary change to gives us the optimal form.

Moving on to the suffixed forms where no intrusive stop formation takes place, notice

that the constraint *GLOTT-S# is so defined that it is not expected to play a role in these forms.

(75) DEP-IO is not violated

Input: /np ^h ǣʔsk/	*GLOTT-S#	DEP-IO
a. np ^h ǣʔsk		
b. np ^h ǣʔtsk		*!

So then, the form identical to the input, candidate (a) wins since neither *GLOTT-S# nor DEP-IO need be violated in order to obtain the optimal surface form.

In addition, the OCP again is invoked in these cases just when a glottalized velar stop follows a /ʔs/ cluster word finally because of contiguous laryngeal features.

Coincidentally, /k' / is the only glottalized stop that can occur in a syllable coda.

(76) /np^hǣʔsk' / [np^hǣsk'] 'your lily'
 /ʃkiʔpjǣʔsk' / [ʃkiʔpjǣsk'] 'your toad'

In (76), the glottal stop of /ʔs/ deletes before /k' / a violation of MAX-IO in parallel fashion to the deletion process described for /pw/ onsets described above and /wp/ codas to be described below. In short, a predictable aspect of the OCP in Northern Pame is the

deletion of one of the violating segments.

(77) Deletion preserves OCP

Input: /np ^h æʔs/	OCP	MAX-IO
a. np ^h æʔsk'	*!	
b. np ^h æsk'		*

Morphological alternations of the sort described for /ʔs/ clusters are hard to come by for parallel cases involving /ʔʃ/, yet the same process appears to be at work. One example of a /ʔʃ/ followed by the consonant /p/ is found in the word /mʔʃ'ũʔʃp/ [mʔʃ'ũʔʃp] 'runt', which patterns the same way.

5.4.5. /*wp, *jt/ but /jk/ clusters

The discussion on Northern Pame onsets revealed that clusters of a coronal or dorsal consonant plus a palatal glide, or a bilabial consonant plus a labio-velar glide would respectively always coalesce or delete. This was explained as a violation of UNIF-IO or MAX-/w/ driven by a markedness constraint to not have adjacent identical place features (i.e. OCP). Not surprisingly, the mirror image glide+consonant clusters arise in Northern Pame codas and the same coalescence or deletion process occurs. The exceptional cases are the glide+dorsal clusters, which resist coalescence.³⁸

³⁸ Note that the voiced suffixes subsequently devoice in word final position.

(78) Coalescence of labial consonants

UNMODIFIED STEM	SUFFIX	MODIFIED STEM	
/gədew/	+ b	/gədəp/	'his youth (son)'
/ʃihjáhaw/	+ b	/ʃihjáhap/	'his fox'
/səhǎw/	+ b	/səhǎp/	'thank him!'
/gəsáw/	+ b	/gəsáp/	'his teacher'
/ʃiŋkjǎw/	+ b	ʃiŋkjǎp	'his rat'

(79) Coalescence of coronal consonants

UNMODIFIED STEM	SUFFIX	MODIFIED STEM	
/náwn/	+ d	/náwnt/	'eat!'
/sín/	+ d	/əsínt/	'open!'
/k'inhjéjʔ/	+ d	/k'əhétʃ' /	'enter!'
/náhaj/	+ d	/k'unáhatʃ/	'joke!'
/əməʔaj/	+ d	/k'əməʔatʃ/	'stop!'
/n ^h úhūp/	+ d	/n ^h úhūntʃ/	'pass!'

(80) Faithfulness of dorsal consonants

UNMODIFIED STEM	SUFFIX	MODIFIED STEM	
/ləʔmáj/	+ g	/ləʔmájk/	'he helps me'
/náhəj/	+ g	/náhəjk/	'he jokes with me'
/n ^h úhūp/	+ k'	/n ^h úhūpk' /	he passes by you
/libjáj/	+ k'	/libjájk' /	'he falls on you'

The exceptional cases codas can be accounted for by considering the morphological place status of the consonants in question. Typically, Northern Pame words are morphologically complex at both edges of a word. As the examples in (78)-(80) illustrate, right edge morphemes exist that are bilabial, coronal and dorsal. However, it is likewise true that Northern Pame words exist that have bilabial and coronal right edge codas that are not morphemes, but rather are part of the lexical root. However, no dorsal consonant suffix has been identified in the present corpus that is not a grammatical morpheme.

(81) MAX_μ-/g/, MAX_μ-/k'/

'Output segments have input correspondents for velar stop morphemes'

Thus, this research suggests that the glide-dorsal exceptions can be explained by ranking dorsal word final codas, all of which are grammatical morphemes, sufficiently high so as to

keep them faithful and thus, more recoverable for grammatical reasons.

(82) Faithfulness of word final /g/ morphemes (excluding devoicing constraints)

Input:	/lɛʔmájg/	MAX _μ /g/	OCP	MAX-/g/
a.	/lɛʔmátʃ/	*!		
b.☞	/lɛʔmájk/		*	

(83) Faithfulness of word final /k' / morphemes

Input:	/n ^h úhūjk' /	MAX _μ /k' /	OCP	MAX-/g/
a.	n ^h úhūjk'	*!		
b.☞	n ^h úhūjk'		*	

5.5. Conclusion

Northern Pame syllable structure exemplifies a number of interesting facts. Among consonants in syllable onsets, we see that complexity is allowed although only with certain combinations of segments. One governing constraint family is the Obligatory Contour Principle (OCP). It has been shown that the OCP blocks surface forms from having adjacent labial, coronal and dorsal articulations. As a way to not violate the OCP, Northern Pame phonology has chosen segmental deletion or in some cases, coalescence.

Regarding nuclei, vowel combinations are disallowed while contrastive nasalization is quite productive. An interesting scenario of nasal consonant pre-stopping occurs when a

nasal consonant follows an oral vowel via a delay in the lowering of the velum. This process is compared to anticipatory nasalization of English vowels which are allophonically nasalized due to a violation of low ranked IDENTITY:V[nasal]. Northern Pame reverses the situation so that IDENTITY:C[nasal] is violated, thus always preserving the nasal setting of the vowel. This makes sense in a language such as Northern Pame, where there exists a distinction between oral and nasal vowels for lexical meaning.

Finally, Northern Pame codas, like onsets, are also restricted by several important constraints. One of the most productive (i.e. high ranking) constraints is Obstruent Coda devoicing. Another is the Coda Condition among nasals, which will parasitically acquire their place specification from a following stop, or if the nasal coda is simple, from the dorsal articulator of the previous vowel. Also, there is a restriction final /ʔs/ resulting in intrusive stop formation.

CHAPTER 6

LARYNGEALIZATION

6.1. Introduction

Laryngeal and laryngealized segments are productive in various aspects of Northern Pame phonology. Glottal stops and aspiration can be part of lexical as well as non-lexical morphemes and are subject to various morphophonemic processes. Likewise, laryngeal segments on lexical roots may appear in intervocalic position giving them the appearance of a sequence non-modal voice quality.

This chapter provides further support in favor of a segmental approach to laryngeally ambiguous vowels via evidence obtained from a laryngealoscopic investigation. Such evidence is treated as secondary to the phonological support provided in chapters 3 and 4 for several reasons. First, it is a well established fact that phonetics are not always in a one to one relationship with phonemes, but are subject to various kinds of articulatory variation. Due to the invasive nature of a laryngealoscopic exam, it is impossible to collect a large enough corpus to filter out these articulatory differences. Even more, some of the data are more transparent than others as to whether a glottal stop or creaky voice is phonetically produced, the latter being considered a phonetic variant of an underlying glottal stop. Second, the evidence provided here is purely static rather than dynamic in its representation. For example, in illustrating the production of a glottal stop, the primary gestures are

presented through static photos. However, in reality the gesture is a dynamic one just as all phonetics is a dynamic process.

6.1.1. Anatomical overview

The larynx is made up of a number of cartilages that are connected to one another by various muscles and ligaments. Its basic function is that of a valve which can do one of the following things: allow air to pass through, cut off the inspiration of air to the lungs or trap air in the lungs for diaphragm support (such as when one lifts something heavy). In speech production, the larynx is responsible for producing obstruents such as laryngeal fricatives and glottal stops, complex segments involving laryngeal co-articulations, as well as voice quality adaptations for sonorants via an adjustment of vocal fold adduction.

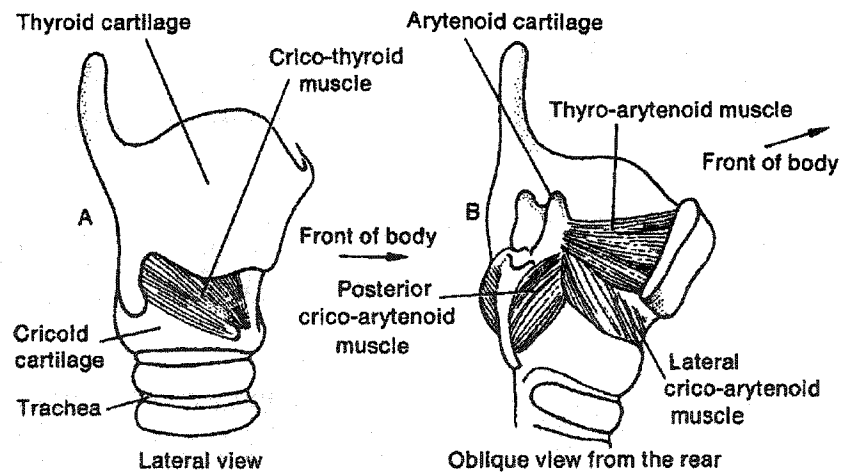

FIGURE 6-1. Lateral and posterior views of larynx (Lieberman 1977).

Figure 6-1 illustrates the larynx from two different views; the lateral view (left picture) and the posterior view (right picture). Looking at the cartilages first, the Thyroid sits on top of the Cricoid cartilage while surrounding the glottis (the space between the vocal folds). Its anterior portion (what faces the front of the body) has a large solid front that makes up the Adam's Apple. The Cricoid cartilage sits below the thyroid and above the trachea. Surrounded by the Thyroid and above the Cricoid cartilages rest the Arytenoid cartilages, the primary cartilages involved in vocal fold phonation. The Arytenoid cartilages rest posterior to the glottis.

Cartilage material is quite rigid and must be moved by muscles of which there are a number involved in speech production. First, the Thyroid-arytenoid muscle makes up the principal mass between the Arytenoid and Thyroid cartilages and contains the ligaments that make up the vocal folds. When it contracts, it tends to pull the Arytenoids towards the Thyroid while adducting (i.e. closing) the glottis, a characteristic of glottal stops. The Thyroid-arytenoid muscle also is responsible for vocal fold tension which produces changes in fundamental frequency. This is accomplished by rocking the Cricoid cartilage up and the Thyroid cartilage down in order to stretch the vocal folds longitudinally. The Arytenoid cartilages are adducted by the contraction of the Interarytenoid and Lateral crico-arytenoid muscles. When these muscles contract and the Arytenoids are pushed together, the vocal folds are in a contact position for phonation in what is known in physiological terms as "medial compression". It is the constant readjustment of the Interarytenoid and Lateral crico-arytenoid muscles that produce the rapid changes from phonation, aspiration and breathing in

human speech. Conversely, the Arytenoid cartilages are abducted (i.e. opened) by the contraction of the Posterior crico-arytenoid muscles. Both the Lateral and Posterior crico-arytenoid muscles run from the Cricoid cartilage up to the Arytenoid cartilages, and therefore are hidden from the view of the laryngoscope.

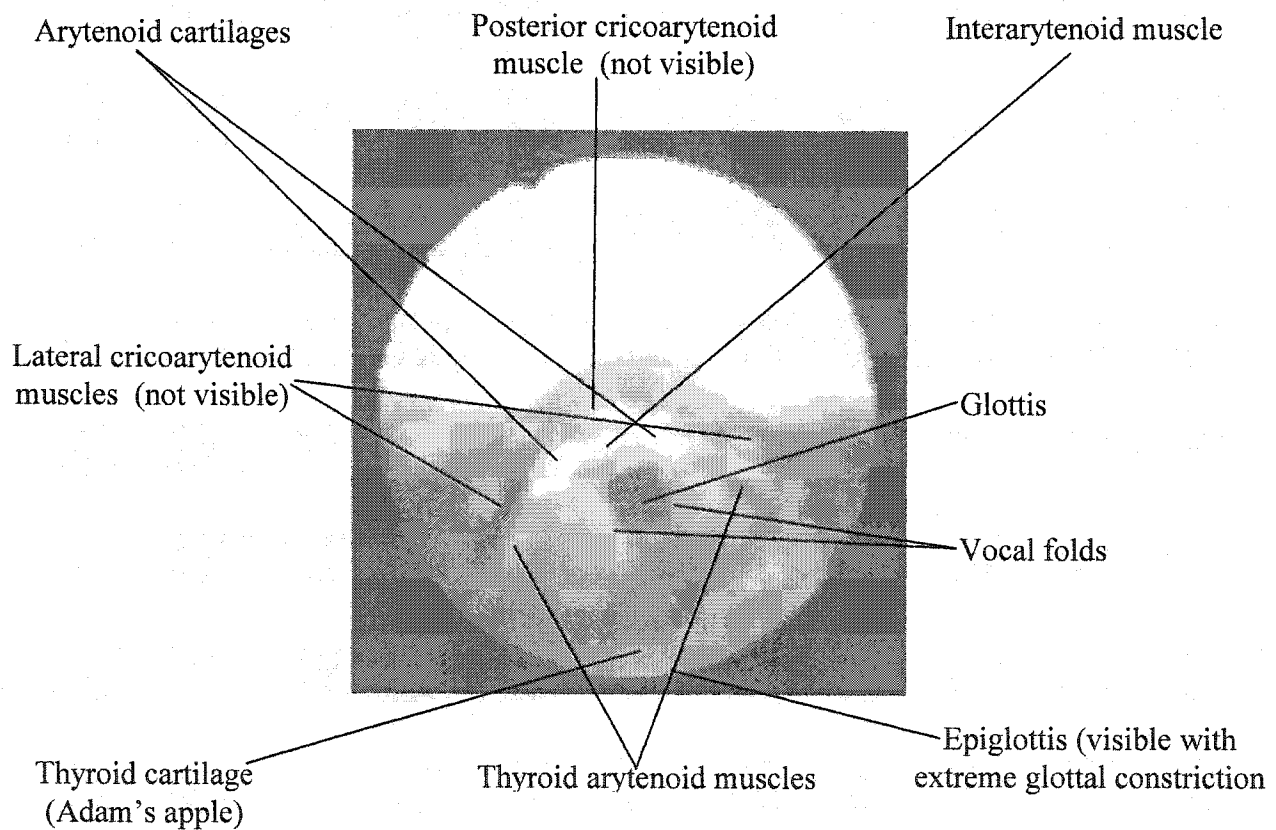

FIGURE 6-2. View of larynx from the apex of the epiglottis with the anterior portion at the bottom, the posterior at the top of the picture.

The picture in figure 6-2 illustrates a laryngeoscopic photo of the larynx during normal breathing. Among other things, notice that the glottis is open in order to permit the maximum of air to pass through. From the laryngeoscopic photo, the Arytenoid cartilages are quite identifiable as two white patches that sit above the glottis. When medial compression is initiated, the vocal folds become clearly seen on the two sides of the glottis, and the space between them decreases immensely. In addition, the Thyroid-arytenoid muscle will contract when producing a glottal stop. When this occurs, the top of the epiglottis comes into view at the bottom of the laryngoscope as the larynx contracts together to shut off the airflow.

Vocal fold phonation involves various kinds of specific articulations within the glottis. The vocal folds themselves are made up of highly elastic ligamental material that can stretch, vibrate or seal to each other depending on what is demanded of them. Vocal folds, however, depend completely on subglottal or supraglottal air pressure passing through the glottis in order to phonate. On their own, vocal folds cannot produce the power to vibrate. The vocal folds are able to discriminate between several *modes* of phonation. Modal phonation or voice, is produced by regular periodic pulsation of air through the glottis. This is achieved by normal vocal fold contact throughout most or all the length of the glottis, and is primarily governed by the adduction of the Arytenoid cartilages. Non-modal phonation is attained by some variation in the configuration of vocal fold adduction and Arytenoid constriction.

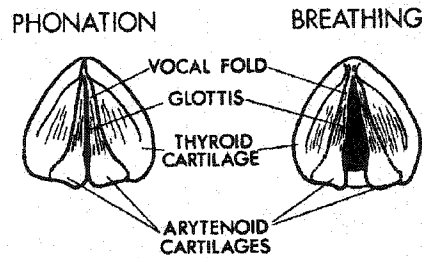

FIGURE 6-3. Vocal folds during phonation and breathing with anterior portion above and posterior portion below (Pickett 1999).³⁹

For example, aspiration and laryngeal frication are achieved by slightly abducting the vocal folds. Yallop and Clark (1995: 20) suggest that the difference between the two is one of air pressure, where aspiration has no additional amount of pulmonic pressure while the laryngeal fricative does. Another non-modal voice quality is breathy voice, which is produced by having both a widening of vocal fold contact, but with concomitant vocal fold vibration. Breathily vowels have more airflow than modal voice vowels due to this slight widening of the glottis. Crucially, breathy voice has the characteristic “chink” between the arytenoids and the vocal folds.

On the other side of the spectrum is creaky voice, which is produced with the vocal folds constricted slightly more than with modal voice so that only a portion of the folds are able to vibrate. Creaky voice vowels usually show anterior vocal fold vibration only and much less airflow than modal voice vowels (Ladefoged and Maddieson 1996: 48).

6.2. Northern Pame laryngeal segment production

The following tables represent the words that were elicited for this laryngealscopic

³⁹ Figures 6-2 and 6-3 are views inverted with respect to one another.

investigation of Northern Pame. All of the words in table 1 contain a glottal stop in onset, intervocalic and coda position. It is important to note that the principal difference between the onset and intervocalic columns is the place of pitch-accent, where the latter is always post-tonic and the former is always pre-tonic. Post-tonic glottal stops and laryngeal fricatives are the cases of laryngeally ambiguous vowels where VʔV or VhV have been interpreted as single units rather than a series of segments as is proposed in this analysis. However, the pre-tonic glottal stop forms are segmentally unambiguous and can be independently proven to be so through morphological derivations.

TABLE 6-1. Elicitation list for glottal stops in onsets, intervocalic and coda positions

ʔV		VʔV		Vʔ	
/ʃkíʔĩ/	'smoke'	/gəp ^h éʔe/	'mosquito'	/nəʃíʔ/	'your shoulder'
/skənʔǎ/	'his hand'	/pǎʔǎ/	'he counts'	/st'wǎʔ/	'sheep'
/nʔéj/	'my child'	/tʃsǎʔəj/	'nurse'	/ntéʔ/	'big'
/mʔú/	'dried'	/súʔut/	'he breaks'	/gǎʔmúʔ/	'turtle'

The examples in table 6-2 exactly parallel that of table 1 with the exception that the laryngeal fricative takes the place of the glottal stop. In addition, note that laryngeal fricative codas are not included since these are not phonemically contrastive in Northern Pame words.

TABLE 6-2. Elicitation list for laryngeal fricatives in onsets and intervocalic positions

hV		VhV	
/rhín/	'grandfather'	/np ^h ǎhǎʔ/	'mat'
/nhǎ/	'cough'	/pǎhǎ/	'he brings'
/səl ^h és/	'scissors'	/kwéhə/	'he finds'
/hǔts/	'he sets hard'	/npúhu/	'his chair'
/hjéʔ/	'you'	/páhawʔ/	'he watches'

Table 6-3 represents a morphological change that occurs on possessive⁴⁰ nouns that includes some laryngeal feature on the root. This can be seen on the unmarked form, which deletes when the possessive prefixes are attached.

TABLE 6-3. Morphological paradigms involving aspirated and glottalized consonants.

UNMARKED	1 PERS. SING.	2 PERS. SING.	3 PERS. SING.	
/np ^h úhu/	/n ^h púhu/	/n ^h pǔhu/	/npúhu/	'chair'
/np ^h ǎhǎʔ/	/n ^h pǎhǎʔ/	/n ^h pǎhǎʔ/	/npǎhǎʔ/	'straw mat'
/nts'éʔ/	/n ^h séʔ/	/n ^h sěʔ/	/nséʔ/	'bean pot (big)'
/nts'ěʔ/	/n ^h sěʔ/	/n ^h séʔ/	/nsěʔ/	'tooth'

For example, 'chair' has an aspirated voiceless bilabial stop on the root onset, but

⁴⁰ 1 Pers. Sing. 'first person singular', 2 Pers. Sing. 'second person singular, 3 Pers. Sing. 'third person singular'.

such aspiration is incompatible upon prefixation for possessor. The phonological reasons for this are covered in chapter 7 ‘Morphology’, but the data is included here to illustrate laryngeally complex consonants versus laryngeal consonants.

6.2.1. *Vowel initial laryngeal consonants*

The production of glottal stops and laryngeal fricatives involves a number of laryngeal mechanisms, which work together in a number of ways. Interestingly, although these segments only differ in the value of the phonological feature [continuant], the gestures required to produce each is somewhat more complicated. First, consider the production of a glottal stop in (1) and (2).

(1) /ʔú/ 'he, she, it'

a. breath state

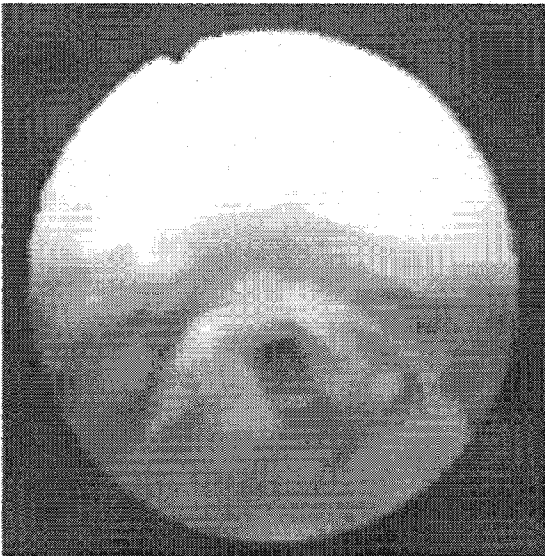

b. Adduction of arytenoids



c. Full closure for /ʔ/

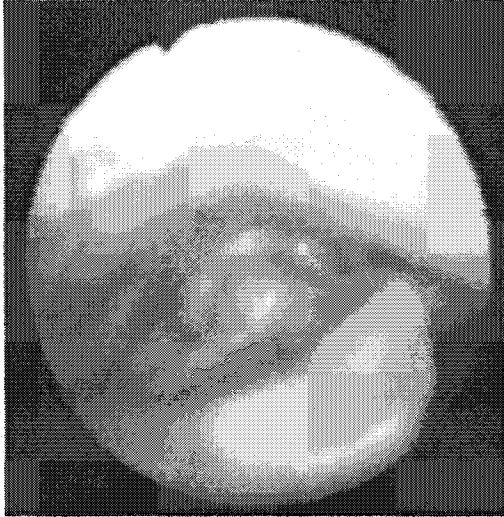

d. Phonation for /u/

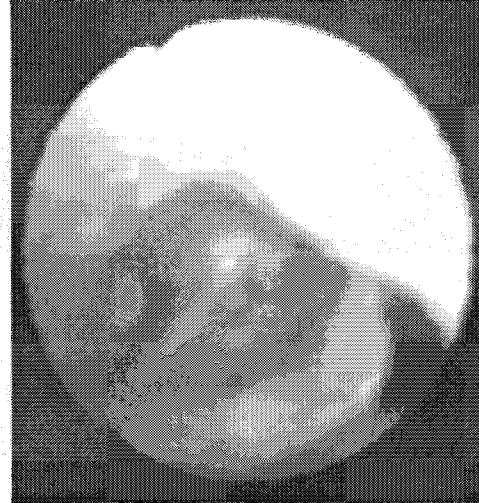

Example (1a) shows the larynx in a breath state. The arytenoid cartilages are wide apart allowing a maximum amount of air possible to pass through the glottis. In between this state and the production of a glottal stop the arytenoids are pulled together as the interarytenoid and lateral cricoarytenoid muscles contract (1b). This has the effect of closing the vocal folds. In order to completely shut-off the airflow for glottal stop production, we see in (1c) that the arytenoids are now pulled forward to the thyroid cartilage with the thyroid arytenoids muscles, which also pulls the epiglottis into view by epiglottal sphinctering (the bottom of (1c)). Finally, in (1d) we see the voicing for the post-glottal stop vowel. Notice that although the arytenoid cartilages are no longer pushed against the thyroid cartilage, they remain constricted to one another (i.e. medial compression) in order for phonation to take place. Here, the vocal folds are clearly seen, pressed uniformly together indicating modal voice.

Another example of glottal stop production is given in (2) where the stop is between two modal voice segments, each comprising a syllable peak. The first peak is the syllabic nasal which is produced with modal voice. This is seen in (2a) where the vocal folds are uniformly pressed together with constricted arytenoid cartilages. The glottal stop follows in (2b) with the arytenoids pulled together as well as pulled forward to the thyroid cartilage. Example (2c) shows the following modal voice vowel in more or less an identical configuration as the modal voiced nasal in (2a).

(2) /mʔú/ 'dried'

a. Phonation of /m/

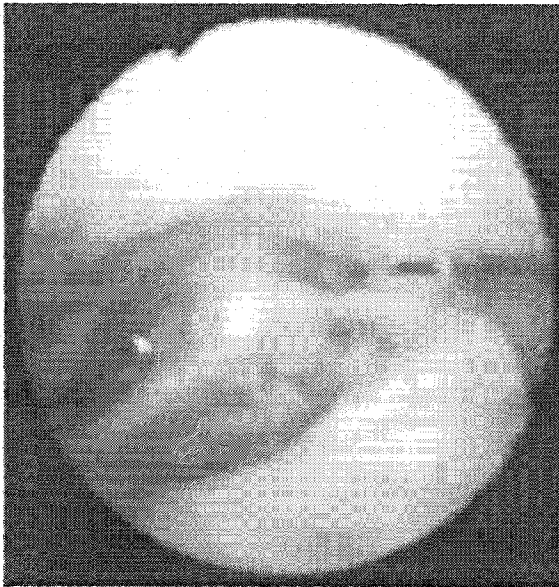

b. Full closure for /ʔ/

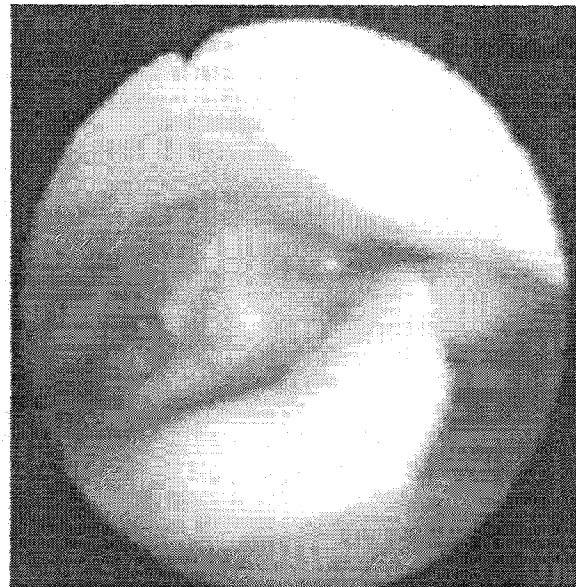

c. Phonation for /u/

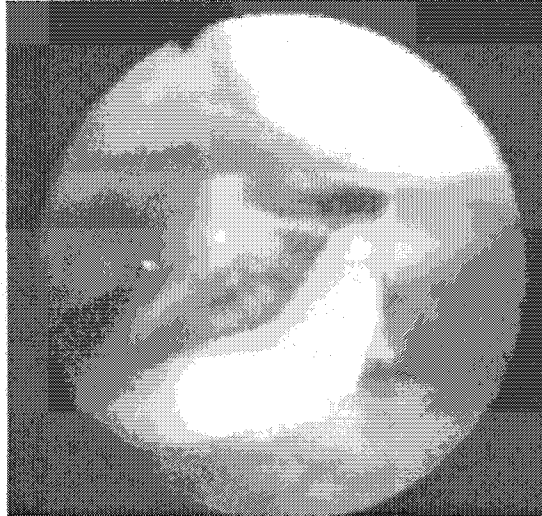

The next example is that of a laryngeal fricative /h/. In (3) the laryngeal fricative onset is observed followed by a modal-voice glide.

(3) /hjé?/ 'you'

a. Partial adduction of arytenoids for /h/ b. Phonation for /jə/

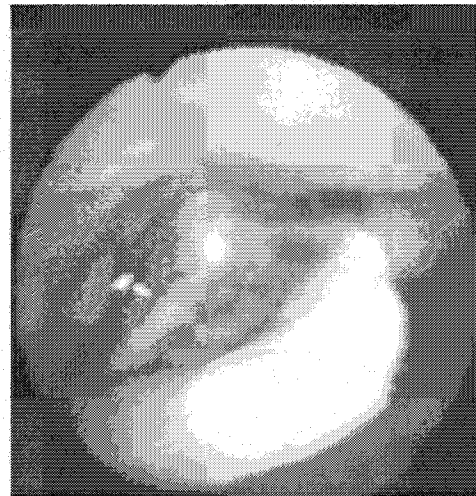
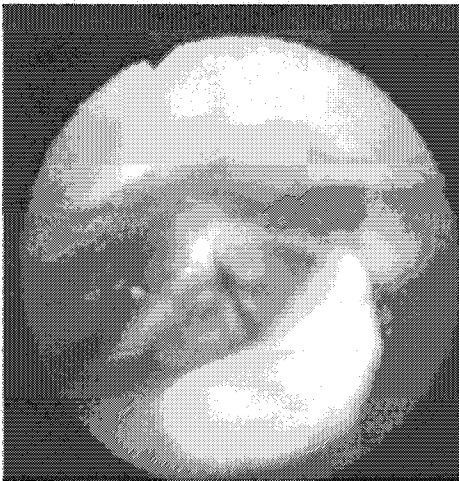

In example (3a), we see that the arytenoid cartilages are partially pressed together as the musculature works in tandem to bring the vocal folds in a closer proximity to one another without touching. This allows air pressure to build up, increasing the speed by which the air molecules pass by the vocal folds giving a noisy fricative sound. The arytenoid chink can be seen at the posterior end of the vocal folds, below the arytenoids. The production of modal voice in (3b) includes bringing the arytenoids completely together in the typical medial compression configuration in order for the following vowel to be phonated.

6.2.2. *Vowel medial laryngeal consonants*

Now, consider the vowel medial glottal stop in (4), which exemplifies the same kind of production or word initial glottal stops.

(4) /suʔut/ he breaks

a. Voiceless for /s/

b. Phonation during /uʔ/

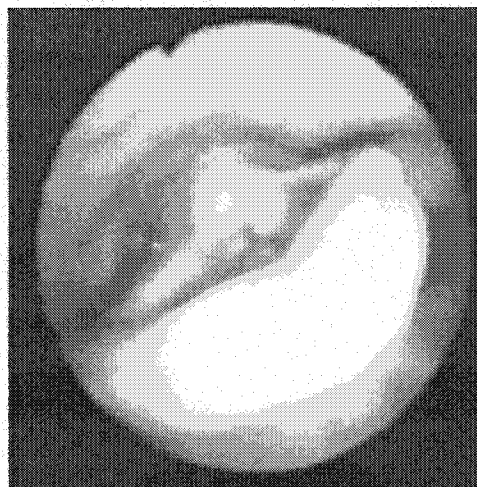
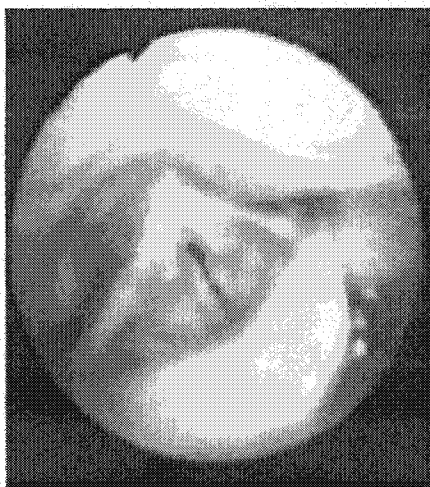

c. Full closure for /ʔ/

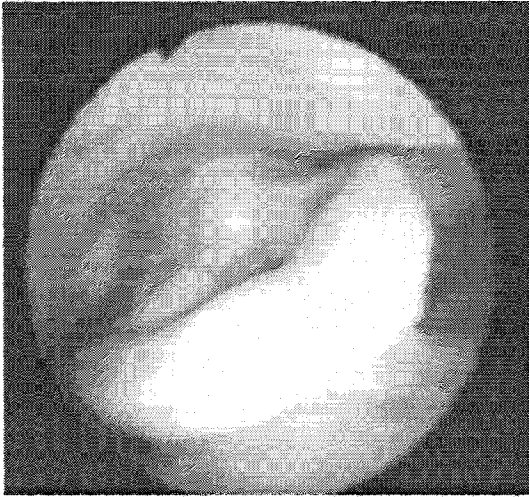

d. Phonation during /ʔu/

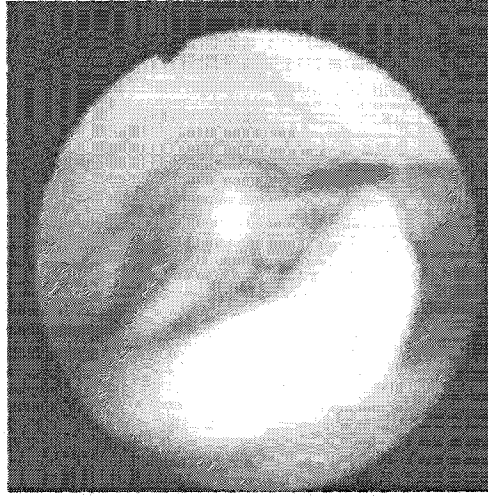

In (4a), we see the state of the vocal folds during the production of the alveolar fricative. Notice, that the arytenoids and vocal folds are far from their resting position as illustrated in figure 3. The arytenoids are partially pulled together and the position of the vocal folds can be likened to a laryngeal fricative in (3a). The difference between the laryngeal fricative, however, lies in that the glottis is longer due to less adducted arytenoid cartilages. Hence, frication is negligible. Photo (4b) illustrates a modal voice vowel, yet with the thyroid arytenoid muscle already contracting to form the glottal stop in (4c). Example (4d) is the vowel that follows the glottal stop, which looks identical to (4b). The difference is that the thyroid arytenoid muscle is now relaxing instead of constricting. What is most noticeable here is the slight adjustment of the thyroid arytenoid muscle constriction required from a modal voice vowel to a glottal stop and vice versa.

A vowel medial laryngeal fricative is illustrated in (5).

(5) /np^húhu/ 'chair'

a. Phonation for /np^h/

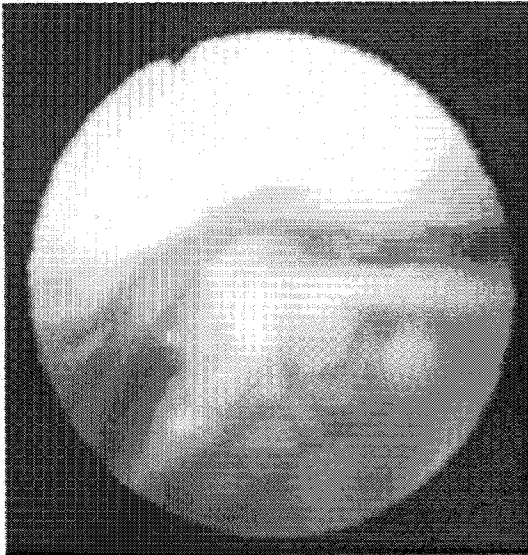

b. Phonation for /p^hu/

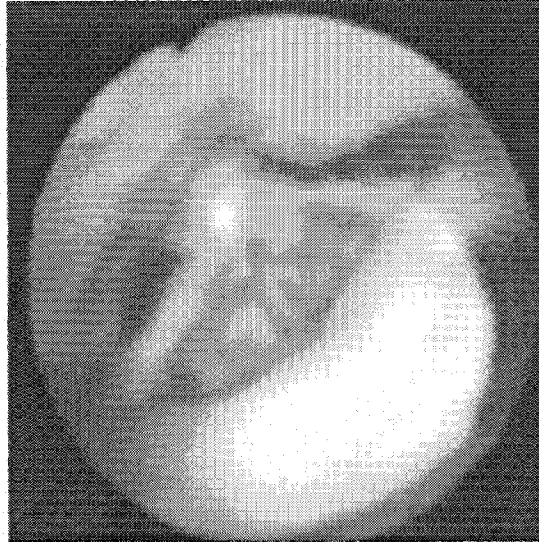

c. Production of /h/

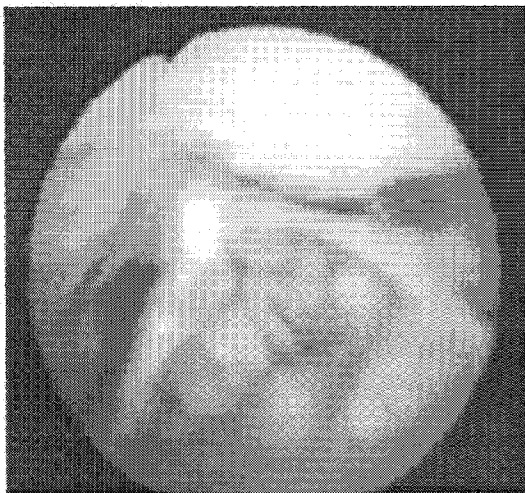

d. Phonation for /u/

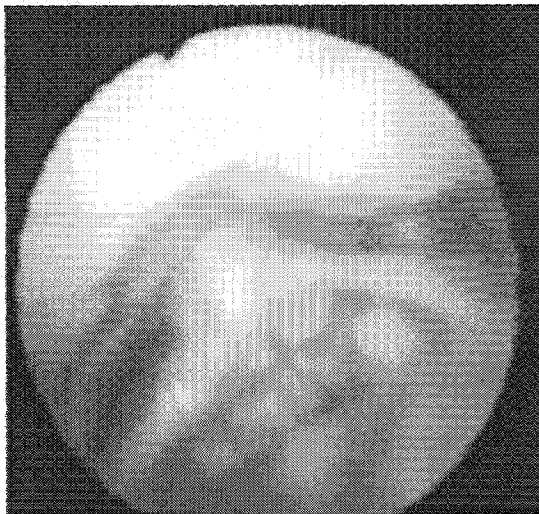

Here we see a modal-voice nasal moving into the voicelessness/aspiration of the following

stop. Example (5b) shows constricted arytenoid cartilages, but with the vocal folds touching in their posterior portion. This implies that there is some amount of residual aspiration on the following vowel. The laryngeal fricative is seen in intervocalic position in (5c) where the amount of glottal longitudinal space is increased, yet not to the full extent that we see in (3a). This is due to the rapid readjustment required for modal voice of the last vowel.⁴¹

6.2.3. *Vowel final laryngeal consonants*

Northern Pame glottal stops are contrastive word finally while the laryngeal fricative is not. Example (6) is a good example. In (6a), we see the arytenoid cartilages contracted in medial compression for the phonation of the nuclear vowel. The arytenoids are closer than normal to the thyroid cartilage in anticipation of the glottal stop, yet modal voice persists.

(6) /ntéʔ/ 'big'

a. Phonation for /ə/

b. Full closure for /ʔ/

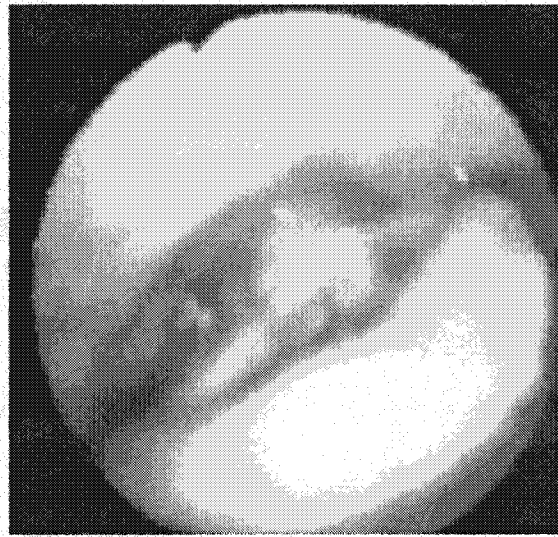
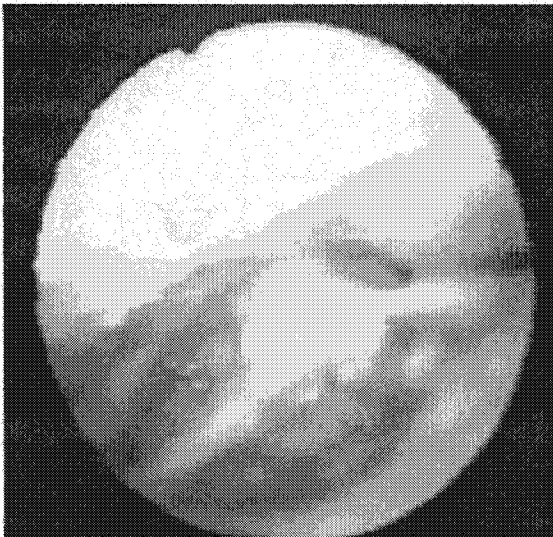

⁴¹ This is a case where a breathy voice argument could be made, although the phonological evidence suggests that this is predictable variation of VhV.

c. Glottal release towards breath state

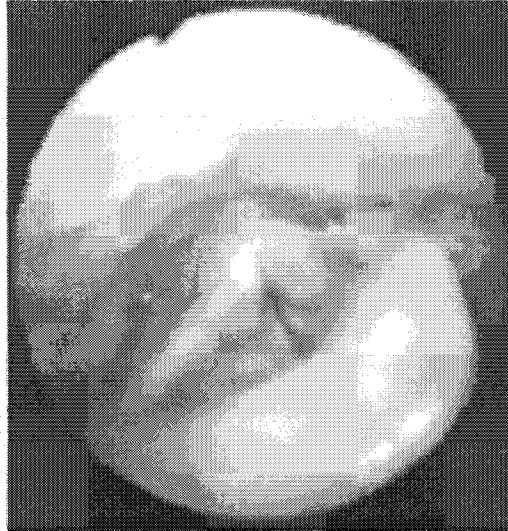

The glottal stop coda is produced in (6b) and its subsequent release in (6c). Notice that the release of the glottal stop is nearly identical to the articulation of the laryngeal fricative in (3a). In fact, Northern Pame word final release contains a great amount of aspiration as the example in figure 8 in chapter 3 illustrates. The example in (6c) confirms that this perception of Northern Pame release is justified in articulatory terms.

6.3. Conclusion

Northern Pame laryngeal segments in vowel initial, medial and post position all manifest similar articulations. For example, vowel initial glottal stop is articulated with arytenoid cartilage adduction and subsequent constriction of the arytenoid thyroid muscle. Intervocalic glottal stops show a similar articulation of both gestures. An important aspect here is the apparent non-existence of the production of creaky vowels in the data base. Likewise, the articulatory differences between a vowel initial and intervocalic laryngeal

fricative are negligible. These data confirm that phonological evidence that laryngeally ambiguous vowels are best interpreted as phonological sequences rather than as laryngeally complex vowels.

CHAPTER 7

MORPHOLOGY

7.1. Introduction

Northern Pame words are typically morphologically complex for all its word classes and it contains discrete categories for morphological contrast and furthermore, these categories tend to fuse together both in meaning and in phonological structure. Such a predicament places Northern Pame squarely in the typological class of an inflectional language.

Separating nouns from verbs is not an easy task in Northern Pame. This is due to the considerable amount of 'shared' morphology between the two word classes among word suffix clitics that attach to both. Furthermore, nouns and verbs often share lexical roots with a wide variety of derivational morphology that complicates their exact identity. However, certain clear patterns do exist, the bulk of which is represented here.

The chapter begins by providing a sketch of noun morphology, which includes classification, possession and number. The second half continues with verb morphological classes focusing on their relationship to transitivity. Following verbal morphology proper, other verbal concepts are summarized that are related to the base form.

7.2. Noun morphology

Northern Pame noun morphology marks three basic categories outside the lexical

root: 1) noun class, 2) noun possessor person, and 3) noun number and alternatively, number of the possessor. Each of these three notions overlap one another to create a rich variety of possible surface forms.

TABLE 7-1. Possible classifier-possession combinations

NOUN CLASS	SEMANTIC DOMAIN	POSSESSION MORPHOLOGY TYPE/S	TONE POSSESSION STEM?	INFLECTED FOR NUMBER?
N-CLASS	'Default'	{J, N/H, B/R}	yes	Yes (prefix)
S-CLASS	'Instrumental'	N/T	yes	No
ANIMATE CLASS	'Animals and People'	{J,B/R}	no	Yes (suffix)

As table 7-1 illustrates, each noun class category may or may not use certain possession morphology. For example, the third person possessor form of the N-class root $/-t\acute{s}'\acute{e}ʔ/$ 'pot' is $/nʔt\check{\jmath}'\acute{e}ʔ/$, which has the characteristic palatalization of the root initial consonant among other prefix elements to be discussed shortly. On the other hand, a S-class root such as $/-s\check{i}n/$ 'key' will never have a third person possessor such as $/*nʔ\check{\jmath}\check{i}n/$, but rather $/s\acute{e}ns\check{i}n/$ 'his key' via a different possessor paradigm. Likewise, some utilize a tonal possessive stem while others do not such as a high tone $/nt\acute{s}'\acute{e}ʔ/$ 'pot' versus a rising tone $/nt\check{\jmath}'\acute{e}ʔ/$ 'your pot'. In addition, one class (the S-class) is not inflected for number as are the other two. Thus, to express 'spoons', one must use the periphrastic $/ba\acute{e} s\acute{e}lh\acute{a}wʔ/$

(lit. 'many spoons') and not /*səlháwʔdət/ or /*ʔháwʔ/.

In addition, classification and possession share some mutual dependence. Thus instruments, if possessed, must be marked according to the n/t class for instrumental possession. Conversely, no other noun class uses this possession paradigm. Also, when a member of the animate class is possessed, the classifier changes to the default (N) class. Thus, /gəp^hé/ 'pig' is classified with the animate prefix /gə-/ as unpossessed, but if the root is inflected for possessor as in /-ʔp^hé/ 'my pig' the N-class prefix /n-/ must be attached in place of /gə-/. However, if 'pig' is merely associated with the suffix class, the animate classifier remains /gəp^hék/ 'my (associative) pig'

A final category that is morphologically productive in Northern Pame nouns is that of number, which includes both duality and plurality. Number is indicated with dual and plural suffix clitics, which are productive on verbs as well as on noun stems such as the noun pairs /l'æ/ 'man' /ʔ'ædət/ 'men', and verbs /gəʔsúʔ/ 'he fell off' and /gəʔsúʔdət / 'they fell off'.

The notions of class, possession and number are represented over four morphological realizations, two prefix columns and two suffix columns.

TABLE 7-2. Noun word constituent order

PREFIX 2	PREFIX 1	ROOT	SUFFIX 1 (CLITIC)	SUFFIX 2 (CLITIC)
CLASSIFIER/NUMBER	POSSESSION	LEXICAL	ASSOCIATION	NUMBER
n-	ʔj-	t̪s' éʔ		
j-	ʔj-	t̪s' éʔ		
n-		t' á	-k	
		gəp ^h é		-dət

7.2.1. Classification

Virtually all Northern Pame nouns are marked with a classifier, a derivational morpheme that may or may not be related to a semantic domain. The largest class of nouns is prefixed with a 'default' classifier, which historically highly resembles the contemporary indefinite article /ndɑ/. However, the classifier by itself has lost any indefinite grammatical distinction and in fact, the indefinite article is required even when the default classifier is used (e.g. /ndɑ nt' ás/ 'a banana'). Other classifiers include those that derive instruments and human agents, both from verbal roots (e.g. /gə-/ 'human agent' + /sáwʔ/ 'he teaches' /gəsáwʔ/ 'teacher'). Animals can be explicitly marked morphologically in a now closed class, but this classifier falls out of use when the animal is in a possessive relationship. These possessed stems are built on the default n-class as shown

above with 'pig'.

7.2.1.1. *N-class (default)*

The N-class is the most productive of all the classifiers in Northern Pame. Likewise, the semantic domain of this class is so broad that it is fruitless to try to define it semantically. However, if we assume that the structure of the language is built so that all nouns require a fundamental class to be well formed, then we can consider the N-class to be a default class or 'the elsewhere case'.

(1) N-class morphemes

CLASS	SING	PLURAL
DEFAULT	/n-/	/j-//r-/

The N-class is the only class to have a plural morpheme in addition to the form. This coupled with the fact that the N-class is still productive and therefore, an 'open' class morphologically, provides good evidence that the category for number is a hallmark of Northern Pame, even though such a distinction remains typologically rare in Otomanguean.

(2) N-class examples

Singular morpheme	Surface		Plural morpheme	Surface	
[n[p ^j úju]]	/np ^j úju/	'chair'	[j[p ^j úju]]	/p ^j júju/	'chairs'
[n[t̂s'áwn]]	/nt̂s'áwn/	'avocado'	[j[t̂s'áwn]]	/t̂s'áwn/	'avocados'

[n[t ^h úʔ]]	/nt ^h úʔ/	'armadillo'	[j[t ^h úʔ]dət]	/tʃ ^h úʔdət/	'armadillos'
[n[m'æ]]	/nm'æ/	'bed'	[j[m'æ]]	/mbjæ/	'my beds'

In the examples in (2) as with all the others, the stems are transcribed in phonemic form after certain morphophonemic process have taken place. Discussion on these important topics is deferred until chapter 8 (morphophonemics). Suffice it to say at this point that the singular morpheme is quite stable phonologically, while the plural morpheme, a palatal glide, surfaces as palatalization on the stem. The flap allomorph will surface only if a possessive J-class prefix intervenes between the plural prefix and the root as the examples in 7.1.1.2.1 illustrate.

7.2.1.2. S-class (*instrumental*)

Any instrumental idea such as conventional tools and tool like body parts are indicated with an s-class morpheme. This class is morphologically marked only for singular.

(3) S-Class morphemes

CLASS	SING	PLURAL
INSTRUMENT	/sə-/	-

(4) S-class examples

MORPHOLOGICAL INSTRUMENT ⁴²	SURFACE	
[sə ^h [sĩn]]	/sts ^h ĩn/	'key'
[sə ^h [ʔǎs]]	/səlʔǎs/	'knife'
[sə ^h [ʔwǎ]]	/səlʔwǎ/	'pen'
[sə ^h [hǎhanʔ]]	/səl ^h ǎhanʔ/	'soap'
[sə ^h [ʔnjǔwǎ]]	/ʃiʔn ^h ǔwǎ/	'nose'
[sə ^h [ʔn ^h jǔwǎ]]	/ʃiʔn ^h ǔwǎ/	'wing'

S-class nouns are always built on a possession stem, never directly to the root. In the examples in (4), all of the stems are themselves inflected for 'absolutive' with the prefix /^h-/.

7.2.1.3. *Animate classes*

In general, Northern Pame makes a distinction between those things that are animate and those that are not. One example is the two derivational classes for animals and people. The animal system is no longer productive containing a group of approximately 30 lexical items that use this morpheme. The human class, however, is quite productive and represents the standard way of deriving agentive forms, much in the same way that /-r/ functions in English for pairs such as 'mine' to 'miner' or 'bake' to 'baker'.

⁴² The s-class prefix always attaches to stems that have possession prefixes from the n/t instrumental paradigm. Because this paradigm also marks non-possessed instrument (the only class that does coincidentally) s-class prefixes never attach to a bare root, but to a n/t possession class stem.

(5) Animate class morphemes

CLASS	SING	PLURAL
ANIMALS	/gə-/, /gu-/	-
PEOPLE	/gə-/	-

(6) Animate class examples

MORPHOLOGICAL ANIMAL/AGENT	STEM	
[gə[p ^h é]]	/gəp ^h é/	'pig'
[gə[mǽs]]	/gəmə́s/	'spider'
[gə[mí?ə̃]]	/gəmə́?ə̃/	'bee'
[gə[pǎtʃ̃]]	/gəpǎtʃ̃/	'raccoon'
[gə[tén]]	/gətén/	'lion'
[gə[náhaʔ]]	/gunáhaʔ/	'kind of animal'
[gə[sáʔ]]	/gusaʔ/	'eagle'
[gə[sáwʔ]]	/gəsáwʔ/	'teacher'
[gə[sáʔ]]	/gəsáʔ/	'trimmer'
[gə[túʔu]]	/gətúʔu/	'sower'

[gə[m^hín]]

/gəm^hín/ 'game player'

7.2.2. Possession

A second distinction of Northern Pame nouns is their morphological marking for possession. There are four noun possession paradigms which distinguish between things that can be owned (such as a commodity), things that are intrinsically possessed (such as body parts), things that are extrinsically possessed (such as instruments) and things that are associated to an agent, but not necessarily possessed. It goes without saying that these are general categories that summarize most of the cases. There are exceptions, which are assumed to have suffered some kind of semantic change, yet with morphology that reflects a former meaning.

7.2.2.1. J-class (ownership)

This class of possession refers generally to items that are owned. Thus, one owns a piece of paper or a gun because these are items that are acquired through some means of trade. The same can be said of livestock, which are considered a commodity as well as foodstuffs.

(7) J-class morphemes

PERSON	POSSESSOR
--------	-----------

1ST	/ʔw-/
-----	-------

2ND	/əj-/
-----	-------

3RD	/ʔj-/
-----	-------

The phonological shape of this class of morphemes is a good illustration of the kind of phonemic distinctions made at the morphological level. They are the presence of the glottal stop, labio-velar glides, and palatal glides. As the data illustrate below, the latter two quite regularly metathesize, while the glottal stop faithfully maintains linear precedence structure.

(8) J-class morpheme examples

CLASS	POSSESSOR	ROOT	DERIVED STEM	
/n-/	/ʔw-/	/k'éʃ/	/nʔk'wéʃ/	'my piece of paper'
/n-/	/əj-/	/k'ěʃ/	/ntʃ'ěʃ/	'your piece of paper'
/n-/	/ʔj-/	/k'éʃ/	/nʔtʃ'éʃ/	'his piece of paper'
/r-/	/ʔw-/	/núwæ/	/rəʔnúwæ/	'my gun'
/r-/	/əj-/	/núwæ/	/riʔnúwæ/	'your guns'
/r-/	/ʔj-/	/núwæ/	/riʔnúwæ/	'his guns'
/n-/	/ʔw-/	/p ^h é/	/nʔp ^h é/	'my pig'
/n-/	/əj-/	/p ^h ě/	/np ^h í/	'your pig'
/n-/	/ʔj-/	/p ^h é/	/nʔp ^h í/	'his pig'
/r-/	/ʔw-/	/mũhũjʔ/	/rəʔmũhũjʔ/	'my squashes'
/r-/	/əj-/	/mũhũjʔ/	/rimjũhũjʔ/	'your squashes'

/r-/ /ʔj-/ /mũhũjʔ/ /riʔmjũhũjʔ/ 'his squashes'

7.2.2.2. *n/h-class (possession)*

This class represents items that are possessed in some intrinsic sense. The clearest examples are body parts as well as items that are traditionally made rather than purchased (e.g. a chair or a pot).

(9) N/H-class morphemes

PERSON POSSESSOR

1ST /^h-/

2ND /^h-/

3RD /ẽ-/

(10) N/H-class examples

CLASS	POSSESSOR	ROOT	DERIVED STEM	
/n-/	/ ^h -/	/p ^h úhu/	/n ^h púhu/	'my chair'
/n-/	/ ^h -/	/p ^h ũhu/	/n ^h pũhu/	'your chair'
/n-/	/ẽ-/	/p ^h úhu/	/npúhu/	'his chair'
/j-/	/ ^h -/	/t ^h s'ěʔ/	/ ^h tʃěʔ/	'my teeth'
/j-/	/ ^h -/	/t ^h s'éʔ/	/ ^h tʃéʔ/	'your.sg. teeth'

/j-/	/ə-/	/tʂ'ěʔ/	/ətʃěʔ/	'his teeth'
/n-/	/ ^h -/	/m'áhaw/	/npáhaw/	'my stomach'
/n-/	/ ^h -/	/m'ǎhaw/	/npǎhaw/	'your stomach'
/n-/	/ə-/	/m'áhaw/	/nmmáhaw/	'his stomach'
/j-/	/ ^h -/	/tʂ'éʔ/	/ ^h tʃéʔ/	'my pots'
/j-/	/ ^h -/	/tʂ'ěʔ/	/ ^h tʃěʔ/	'your pots'
/j-/	/ə-/	/tʂ'éʔ/	/ətʃéʔ/	'his pots'

With possession being distinguished by the presence of either a /^h/ or a /n/, two phonological alternations can be seen, particularly with stem beginning with a laryngeally complex consonant.

7.2.2.3. *n/t-class (instrument possession)*

Possession of an instrument such as a 'spoon' or 'soap' is morphologically marked with the instrumental class of possessive morphemes. Idiosyncratic to this morpheme class is the morpheme indicating the 'non-possessed form' (i.e. base form) in the form of /^h-/.

(11) N/T class morphemes

PERSON POSSESSOR

BASE /^h-/

1ST	/tə-/
2ND	/kəj-/
3RD	/ən-/

(12) N/T-Class examples

CLASS	POSSESSOR	ROOT	DERIVED STEM	
/sə-/	/ ^h -/	/hǎwʔ/	/səl ^h ǎwʔ/	'spoon'
/sə-/	/tə-/	/hǎwʔ/	/stəhǎwʔ/	'my spoon'
/sə-/	/kəj-/	/hǎwʔ/	/ʃkihǎwʔ/	'your spoon'
/sə-/	/ən-/	/hǎwʔ/	/sənhǎwʔ/	'his spoon'
/sə-/	/ ^h -/	/sǐn/	/st ^h sǐn/	'key'
/sə-/	/tə-/	/sǐn/	/stəsǐn/	'my key'
/sə-/	/kəj-/	/sǐn/	/ʃkiʃǐn/	'your key'
/sə-/	/ən-/	/sǐn/	/sənsǐn/	'his key'
/sə-/	/ ^h -/	/ʔǎs/	/səl ^h ǎs/	'knife'
/sə-/	/tə-/	/ʔǎs/	/stəʔǎs/	'my knife'
/sə-/	/kəj-/	/ʔǎs/	/ʃkiʔǎs/	'your knife'
/sə-/	/ən-/	/ʔǎs/	/sənʔǎs/	'his knife'

/sə-/ /^h-/ /kǎʔs/ /sk^hǎʔs/ 'plane (tool)'
 /sə-/ /tə-/ /kǎʔs/ /stəkǎʔs/ 'my plane (tool)'
 /sə-/ /kəj-/ /kǎʔs/ /ʃkitʃǎʔs/ 'your plane (tool)'
 /sə-/ /ən-/ /kǎʔs/ /sənkǎʔs/ 'his plane (tool)'

The productive aspect of this possession class is seen most clearly for tools derived from verbal activities. Should an instrumental noun not be available in the lexicon, a tool can be derived from a syntactic predicate with the verb root having the instrumental classifier plus the 3rd person possessor as in the formula in (13).

(13) [s-[n-[verb root]]] [complement.]

The derived instrument can then be possessed by adding J-class prefixes to the complement.

(14) [sə-[n-[verb root]]] [J-class[complement]]

(15) Instrument derivation examples

ROOT		COMPLEMENT		DERIVED STEM	
máʔaw	'hold'	págas	'meat'	sənmáʔaw	pégás 'fork'
máʔaw	'hold'	nʔkwás	'my meat'	sənmáʔaw	nʔkwás 'my fork'

túʔũ 'sow' ʌ^hũwǎ 'corn seed' sɛntúʔũ ʌ^hũwǎ 'bar for sowing seed'

túʔũ 'sow' rɛtʃ^hũwǎ 'corn seed' sɛntúʔũ rɛtʃ^hũwǎ 'your bar for sowing seed'

7.2.2.4. B/R clitics (association)

One place where Northern Pame syntax and morphology meet is with the associative suffixes, which also function similarly as verbal suffixes of beneficiary or recipient (e.g. English indirect object pronouns). Thus, nouns marked with these suffixes generally fall under the semantic distinction of association, where an item is related to a person in some incidental way. For example, ‘my rat’ is an association for some specific proposition such as ‘my rat (the rat I found in my house) was bigger than your rat (the rat you found in your house)’. There is no intrinsic possession such as a body part nor any ownership (i.e. people don’t typically acquire rats), but simply an understood association in a communication situation. For many things, not all, association is an alternative to ownership or possession depending on the context being described.⁴³

(16) B/R morphemes

PERSON	BENEFICIARY/RECIPIENT
--------	-----------------------

1 ST	/-g/
-----------------	------

2 ND	/-k’/
-----------------	-------

3 RD	/-b/
-----------------	------

⁴³ An area for further study is that of kinship terms.

(17) Verbal beneficiary/recipient examples

VERB	BEN./REC.	DERIVED STEM	
/se/	/-g/	/sek/	'he says to me'
/se/	/-k' /	/sek' /	'he says to you'
/se/	/-b/	/sep/	'he says to him'

(18) Nominal association examples

NOUN	POSSESSOR	DERIVED STEM	
/dintʃáj/	/-g/	/dintʃájk/	'my small squash'
/dintʃáj/	/-k' /	/dintʃájk' /	'your.sg. small squash'
/dintʃáj/	/-b/	/dintʃájp/	'his small squash'
/ʃintʃáw/	/-g/	/ʃintʃáwk/	'my rat'
/ʃintʃáw/	/-k' /	/ʃintʃáwk' /	'your.sg. rat'
/ʃintʃáw/	/-b/	/ʃintʃáp/	'his rat'
/stəkát/	/-g/	/stəkátk/	'my onion'
/stəkát/	/-k' /	/stəkátk' /	'your.sg. onion'
/stəkát/	/-b/	/stəkátp/	'his onion'
/sən'tæ/	/-g/	/sənʔtæk/	'my waistline'

/sən'tæ/ /-k'/ /sənʔtæk'/ 'your waistline'

/sən'tæ/ /-b/ /sənʔtæp/ 'his waistline'

7.2.2.5. *Tone*

One of the most productive areas for Northern Pame morphological tone is with noun possession. This pattern applies exclusively to all the prefix possession (j, n/h, n/t) classes and is quite easy to predict. Namely, the second person possessor is always the opposite tone of the base, 1st and 3rd person possessors. Since Northern Pame only has two contrastive tones, predicting the opposite tone is of no consequence.⁴⁴

(19) Tone paradigm for possession.

PERSON	TONAL PATTERN
UNMARKED	T
1ST	T
2ND	Opposite of T
3RD	T

In the examples in (20), two possession paradigms are given illustrating the unilateral preference of the 2nd person as the bearer of the opposite tone.

⁴⁴ There are a couple of rare exceptions to the two tone analysis such as 'head', where a mid tone is a possible solution. However, these cases are so few that it is difficult to substantiate a third tone with any conclusive argumentation.

(20) Morphological tone examples

2ND PERSON WITH HIGH-TONE		2ND PERSON WITH LOW-TONE	
/st ^h s ^h ĩn/	'key'	/nk' éʃ/	'piece of paper'
/stəsĩn/	'my key'	/nʔk' wéʃ/	'my piece of paper'
/ʃkiʃĩn/	'your key'	/ntʃ' ǎʃ/	'your piece of paper'
/sənsĩn/	'his key'	/nʔtʃ' éʃ/	'his piece of paper'

7.2.3. *Number*

Number is a second area where the waters are muddied between Northern Pame syntax and morphology. Both verbs and nouns can take the same morphology for the categories of duality and plurality with suffix clitics. When they apply to verbs, they inflect the number of the subject (see 7.1.2), or to the indirect object if these affixes are present (see 7.1.1.2.4). When they apply to nouns, they inflect the number of the noun when unpossessed, or the number of the possessor when the noun is marked with possession morphology as described in 7.1.1.2.

7.2.3.1. *Dual and Plural default*

The singular is a morphologically unmarked category. Duality and Plurality, however, are regularly applied to nouns, verbs, adjectives and pronouns as the syntax of the language requires. Notice that there is regular allomorphy among the dual clitics where /-de/ is replaced by /-se/ when attached to a stem ending in a nasal coda.

(21) Dual and plural morphemes

PERSON	SINGULAR	DUAL	PLURAL
UNMARKED	-	/-de/, /-se/	/-dət/

The examples in (22) are all of the base form for various nouns. Notice that no N-class nouns are represented, which is predictable since they have their own plural morpheme prefix. Also, instruments are not inflected morphologically for number in Northern Pame, but rather a dual or plural idea is expressed with a separate adjective.

(22) Dual and Plural examples of unpossessed nouns

ROOT	NUMBER	STEM	
/bətú/	/-de/	/bətúde/	'two dead ones'
/gutén/	/-de/	/guténse/	'two lions'
/ʃiʔjǔj/	/-de/	/ʃiʔjǔje/	'two indigenous people'
/gusaʎ'/	/-de/	/gusaʎ'e/	'two eagles'
/bətú/	/-dət/	/bətúdət/	'dead ones'
/gutén/	/-dət/	/guténdət/	'lions'
/ʃiʔjǔj/	/-dət/	/ʃiʔjǔjət/	'indigenous peoples'
/gusaʎ'/	/-dət/	/gusaʎ'ət/	'eagles'

7.2.3.2. *Dual and plural for possessor*

When a possessed stem is inflected for number, the number applies to the possessor, not the possessed item.

(23) Number of possessor

PERSON	SINGULAR	DUAL	PLURAL
1ST	-	/-je/, /-se/	/-nən/
2ND	-	/-je/, /-se/	/-nən/
3 RD	-	/-je/, /-se/	/-dət/

The data in (24) and (25) contain examples from the N-class of nouns with J-class possessive prefixes. These each illustrate how possessor number is inflected either for dual or plural. Notice that the plural possessed is also expressed via the plural prefix of the N-class in words such as 'our.Dl. squashes'.

(24) Dual possessor (J-class) examples

CLASS	POSSESSOR	ROOT	NUMBER	DERIVED STEM	
/n-/	/ʔw- /	/k' éʃ/	/-je/	/nʔk' wéʃe/	'our.Dl piece of paper'
/n-/	/əj-/	/k' ǎʃ/	/-je/	/ntʃ' ǎʃe/	'your.Dl piece of paper'
/n-/	/ʔj-/	/k' éʃ/	/-je/	/nʔtʃ' éʃe/	'their.Dl piece of paper'
/r-/	/ʔw- /	/mũhũjʔ/	/-je/	/rəʔmũhũjʔje/	'our.Dl squashes'

/r-/	/əj-/	/mũhũjʔ/	/-je/	/rimjũhũjʔje/	'your.Dl squashes'
/r-/	/ʔj-/	/mũhũjʔ/	/-je/	/riʔmjũhũjʔje/	'their.Dl squashes'

(25) Plural possessor (J-class) examples

CLASS	POSSESSOR	ROOT	NUMBER	DERIVED STEM	
/n-/	/ʔw-/	/k'əʃ/	/-nən/	/nʔk'wəʃən/	'our piece of paper'
/n-/	/əj-/	/k'əʃ/	/-nən/	/ntʃ'əʃən/	'your.Pl piece of paper'
/n-/	/ʔj-/	/k'əʃ/	/-dət/	/nʔtʃ'əʃət/	'their piece of paper'
/r-/	/ʔw-/	/mũhũjʔ/	/-nən/	/rəʔmũhũjʔnən/	'our.Pl squashes'
/r-/	/əj-/	/mũhũjʔ/	/-nən/	/rimjũhũjʔnən/	'your.Pl squashes'
/r-/	/ʔj-/	/mũhũjʔ/	/-dət/	/riʔmjũhũjʔdət/	'their squashes'

(26) Dual and Plural possessor (B/R-class) examples

ROOT	POSSESSOR	NUMBER	STEM	
/sənʔtæ/	/-g/	/-je/	/sənʔtæge/	'our.Dl waistline'
/sənʔtæ/	/-k'/	/-je/	/sənʔtæk'e/	'your.Dl waistline'
/sənʔtæ/	/-b/	/-je/	/sənʔtæbe/	'their.Dl. waistline'
/sənʔtæ/	/-g/	/-nən/	/sənʔtægen/	'our.Pl waistline'
/sənʔtæ/	/-k'/	/-nən/	/sənʔtæk'en/	'your.Pl waistline'
/sənʔtæ/	/-b/	/-nət/	/sənʔtæbet/	'their.Pl waistline'

N-class nouns are the only class that can have plural possessed and plural possessor marked

at the same time. Other classes must account for plurality of count possessed nouns through adjectival modifiers.

7.3. Verb morphology

The Northern Pame verb is composed of six basic morpheme categories, or five inflectional categories plus the lexical root. Of the two prefix slots, prefix 1 makes up that of subject person and tense-aspect. The subject is expressed with the near universal categories of 1st, 2nd, or 3rd person with morphemes that are in a portmanteau relationship with tense-aspect. For example, /ləśáwʔ/ 'I teach' /nəśáwʔ/ 'I taught' each contain the respective prefixes of /lə-/ and /nə-/ which refer to first person subject as well as incomplete versus complete tense/aspect. Regarding tense-aspect, there are two primary categories represented in verbal morphology, 'incomplete' and 'complete'. 'Potential' is morphologically marked with prefix 2 morphology. Potential mood, besides referring to an uncertain future event, is also the syntactic marker for dependent clauses. Suffix 1 represents the morphology for recipient or beneficiary concepts, usually equivalent to the syntactic category of indirect object (see chapter 7).⁴⁵ Suffix 2 refers to the number of the subject.

TABLE 7-3. Verb word constituent order

PREFIX 2	PREFIX 1	ROOT	SUFFIX 1	SUFFIX 2	SUFFIX 3
POTENTIAL	SUB.PERSON, NUMBER-TENSE	LEXICAL	REC/BEN	NUMBER	EXCLUSIVITY
nʔ	təj	tsú	k'	ən	

⁴⁵ Notice that the glottalized velar stop is active in the dual and plural as a subject marker, in addition to the number suffixes on all Northern Pame verb paradigms.

Northern Pame verb suffixes are the same as those described for noun possession, thus in reality behaving more like clitics.

(27) Exclusive morphology

	INCLUSIVE	EXCLUSIVE
1ST DUAL/PLURAL	-	/-ʔ/

The one category added here is suffix 3 ‘exclusivity’, which refers to the referential participants in the first person dual and plural subjects. ‘Inclusive’ (the unmarked form) refers to the subject and the recipient as the subjectival referents. ‘Exclusive’ signifies that the recipient is *not* included with the speaker as the subject, but rather, some other participant is.

(28) Exclusivity examples on verb stems.

PRONOUN AND/OR VERB	EXCLUSIVE	STEM	
/tʃáɡwe/	/-ʔ/	/itʃáɡweʔ/	'we.Dl.Ex'
/tʃáɡwən/	/-ʔ/	/itʃáɡwənʔ/	'we.Pl.Ex'
/təɡwǎje/	/-ʔ/	/təɡwǎjeʔ/	'we.Dl.Ex are going'
/ɡwǎnən/	/-ʔ/	/ɡwǎnənʔ/	'we.Pl.Ex are going'

7.3.1. *Verb classes*

There are two basic morphological verb classes in Northern Pame, which can be viewed as, 1) the L-class, and 2) the T-class respectively. Within each class are two basic types which roughly correspond to transitivity. Thus, in the L-D class we have verbs such as 'break', 'drag', 'hunt', and 'measure', but in the subclass L-G the verbal ideas are 'be angry', 'drown', 'shout' and 'fall off'.⁴⁶

The name of each verb class is derived from the consonant of the 1st person singular incomplete and the 3rd person singular complete morphology, which seem to be the most regular parts of these complex paradigms.

7.3.1.1. *L-D class*

The L-D class is characterized by a labio-velar glide morpheme in the third person, and very predictable complete and potential morphology. However, as is common in Northern Pame, prefix 1 often alternates a labio-velar glide for a palatal glide depending on the TAM (tense-aspect-modality) category. For example, the third person plural incomplete and complete have a labio-velar glide, but the potential is characterized with a palatal glide.

⁴⁶ Since the goal of this chapter (indeed of the entire project) is to ascertain Northern Pame phonological aspects of its morphology, not their syntactic properties, no further comment will be offered on the syntactic implications of these classes, except where obvious patterns warrant an explanation.

TABLE 7-4. L-D verb paradigm

SUBJECT	INCOMPLETEIVE			COMPLETIVE			POTENTIAL				
	P1	S1	S2	P1	S1	S2	P2	P1	S1	S2	
SINGULAR	1 ST	lə-	-	-	nəw-	-	-	nʔ-	w-	-	-
	2 ND	k'əj-	-	-	nəj-	-	-	nʔ-	-	-	-
	3 RD	w-	-	-	dəw-	-	-	nʔ-	-	-	-
DUAL	1 ST	tə-	-	-je	nəw-	-	-je	nʔ-	w-	-	-je
	2 ND	tə-	-k'	-je	nəj-	-	-je	nʔ-	-	-	-je
	3 RD	w-	-	-je	dəw-	-	-je	nʔ-	-	-	-je
PLURAL	1 ST	-	-	-nən	nəw-	-	-nən	nʔ-	w-	-	-nən
	2 ND	-	-k'	-nən	nəj-	-	-nən	nʔ-	-	-	-nən
	3 RD	h-, w-	-	-	də-, h-, w-	-	-	nʔ-	h-, j-	-	-

TABLE 7-5. L-D verb examples with /kǎʔs/ 'set. soft'

SUBJECT	INCOMPLETEIVE	COMPLETIVE	POTENTIAL	
SINGULAR	1 st	/ləkǎʔs/	/nəkǎʔs/	/nʔkwǎʔs/
	2 nd	/k'ətʃǎʔs/	/nətʃǎʔs/	/nʔkǎʔs/
	3 rd	/kwǎʔs/	/dəkwǎʔs/	/nʔkǎʔs/
DUAL	1 st	/təkǎʔse/	/nəkǎʔse/	/nʔkwǎʔse/
	2 nd	/təkǎʔsk'e/	/nətʃǎʔse/	/nʔkǎʔse/
	3 rd	/kwǎʔse/	/dəkwǎʔse/	/nʔkǎʔse/
PLURAL	1 st	/kǎʔsən/	/nəkǎʔsən/	/nʔkwǎʔsən/
	2 nd	/kǎʔsk'ən/	/nətʃǎʔsən/	/nʔkǎʔsən/
	3 rd	/k ^h wǎʔs/	/dək ^h wǎʔs/	/nʔtʃ ^h ǎʔs/

Finally, it will be observed that the third person plural of this class is only marked with verbal prefix, in this case the feature [+sg].

7.3.1.2. L-G class

The L-G subclass represents some typical properties for intransitive morphology in Northern Pame.

TABLE 7-6. L-G verb paradigm

SUBJECT	INCOMPLETEIVE			COMPLETIVE			POTENTIAL				
	<u>P1</u>	<u>S1</u>	<u>S2</u>	<u>P1</u>	<u>S1</u>	<u>S2</u>	<u>P2</u>	<u>P1</u>	<u>S1</u>	<u>S2</u>	
SINGULAR	1 st	lə-	-	-	tə-	-	-	nə-	-	-	-
	2 nd	k'əj-	-	-	k'əj-	-	-	nʔ-	k'ə-	-	-
	3 rd	-	-	-	gə-	-	-	nə-	-	-	-
DUAL	1 st	tə-	-	-je	təj-	-	-je	nʔ-	təj-	-	-je
	2 nd	tə-	-k'	-je	təj-	-k'	-je	nʔ-	təj-	-k'	-je
	3 rd	-	-	-je	gə-	-	-je	nə-	-	-	-je
PLURAL	1 st	tə-	-	-nən	təj-	-	-nən	nʔ-	tə-	-	-nən
	2 nd	tə-	-k'	-nən	təj-	-k'	-nən	nʔ-	tə-	-k'	-nən
	3 rd	-	-	-dət	gə-	-	-dət	n-	-	-	-dət

TABLE 7-7. L-G verb examples with /ə̀tsúʔ/ 'fall off'

SUBJECT	INCOMPLETIVE	COMPLETIVE	POTENTIAL
SINGULAR	1 st /lə̀tsúʔ/	/tə̀tsúʔ/	/nə̀tsúʔ/
	2 nd /k'ə̀tʃúʔ/	/k'ə̀tʃúʔ/	/nʔk'ə̀tsúʔ/
	3 rd /ə̀tsúʔ/	/gə̀tsúʔ/	/nə̀tsúʔ/
DUAL	1 st /tə̀tsúʔje/	/tə̀tʃúʔje/	/nʔtə̀tʃúʔje/
	2 nd /tə̀tsúʔk'e/	/tə̀tʃúʔk'e/	/nʔtə̀tʃúʔk'je/
	3 rd /ə̀tsúʔje/	/gə̀tsúʔje/	/nə̀tsúʔje/
PLURAL	1 st /tə̀tsúʔnən/	/tə̀tʃúʔnən/	/nʔtə̀tʃúʔnən/
	2 nd /tə̀tsúʔk'ən/	/tə̀tʃúʔk'ən/	/nʔtə̀tʃúʔk'ən/
	3 rd /ə̀tsúʔdət/	/gə̀tsúʔdət/	/ntsúʔdət/

Most obvious is the potential, which unlike the L-D class, is derived from the incomplete stem rather than off the lexical root. The result is a heavy marking of subject morphology (i.e. that of the incomplete and the potential) and usually no direct object in the syntax.

Notice also that the complete morphology is radically different from the L-D class.

Likewise, this class is unique in that it marks the third person plural exclusively with clitic suffixes rather than with the more prototypical prefix morphology of the other classes.

7.3.1.3. T-D class

The T-D class is quite easily recognized for its unilateral application of the glottal stop in the P1 prefixes, and it is quite possible that this is a separate morpheme.

TABLE 7-8. T-D verb paradigm

SUBJECT	INCOMPLETEIVE			COMPLETIVE			POTENTIAL				
	P1	S1	S2	P1	S1	S2	P2	P1	S1	S2	
SINGULAR	1 st	təʔ-	-	-	nəʔ-	-	-	nʔ-	-	-	-
	2 nd	k'əʔ-	-	-	nəjʔ-	-	-	nʔ-	-	-	-
	3 rd	ləʔ-	-	-	dəʔ-	-	-	nʔ-	-	-	-
DUAL	1 st	təʔ-	-	-je	nəʔ-	-	-je	nʔ-	-	-	-je
	2 nd	təʔ-	-k'	-je	nəʔ-	-k'	-je	nʔ-	-	-k'	-je
	3 rd	ləʔ-	-	-je	dəʔ-	-	-je	nʔ-	-	-	-je
PLURAL	1 st	təʔ-	-	-nən	nəʔ-	-	-nən	nʔ-	-	-	-nən
	2 nd	təʔ-	-k'	-nən	nəʔ-	-k'	-nən	nʔ-	-	-k'	-nən
	3 rd	əʔ-, t-	-	-	dəʔ-, t-	-	-	nʔ-	j-	-	-

TABLE 7-9. T-D verb examples with /ləʔp^hén/ 'hit'

SUBJECT	INCOMPLETEIVE	COMPLETIVE	POTENTIAL	
SINGULAR	1 st	/təʔp ^h én/	/nəʔp ^h én/	/nʔp ^h én/
	2 nd	/k'əʔp ^h én/	/nəʔp ^h ín/	/nʔp ^h én/
	3 rd	/ləʔp ^h én/	/dəʔp ^h én/	/nʔp ^h én/
DUAL	1 st	/təʔp ^h énse/	/nəʔp ^h énse/	/nʔp ^h énse/
	2 nd	/təʔp ^h énk'e/	/nəʔp ^h énk'e/	/nʔp ^h énk'e/
	3 rd	/ləʔp ^h énse/	/dəʔp ^h énse/	/nʔp ^h énse/
PLURAL	1 st	/təʔp ^h énən/	/nəʔp ^h énən/	/nʔp ^h énən/
	2 nd	/təʔp ^h énk'en/	/nəʔp ^h énk'en/	/nʔp ^h énk'en/
	3 rd	/əʔp ^h én/	/dəʔp ^h én/	/nʔp ^h ín/

Likewise, although the completive paradigm is quite divergent from the L-D class, the completive prefixes are much similar in terms of consonants, and likewise the potential forms are identical to the L-D class. Also similar to the L-D class is the preference for prefix marking of the third person plural.

7.3.1.4. *T-N class*

The subclass ‘T-N’ is clearly indicated by a preference for the palatal glide in the incomplete and completive forms. Likewise, the potential is built on the incomplete stem as we have seen with the L-G class of verbs.

TABLE 7-10. T-N verb paradigm

SUBJECT	INCOMPLETE			COMPLETIVE			POTENTIAL				
	<u>P1</u>	<u>S1</u>	<u>S2</u>	<u>P1</u>	<u>S1</u>	<u>S2</u>	<u>P2</u>	<u>P1</u>	<u>S1</u>	<u>S2</u>	
SINGULAR	1 st	təj-	-	-	nəj-	-	-	nʔ-	tə-	-	-
	2 nd	k'əj-	-	-	k'əj-	-	-	nʔ-	k'ə-	-	-
	3 rd	ləj-	-	-	nəj-	-	-	nə-	-	-	-
DUAL	1 st	təj-	-	-je	nəj-	-	-je	nʔ-	tə-	-	-je
	2 nd	təj-	-	-je	k'əj-	-	-je	nʔ-	tə-	-	-je
	3 rd	ləj-	-	-je	nəj-	-	-je	nə-	-	-	-je
PLURAL	1 st	təj-	-n	-nən	nəj-	-n	-nən	nʔ-	tə-	-n	-nən
	2 nd	təj-	-k'	-nən	nəj-	-k'	-nən	nʔ-	tə-	-k'	-nən
	3 rd	təj-, ^h -	-	-	nəj-, ^h -	-	-	nʔ-	tə-, ^h -	-	-

TABLE 7-11. T-N verb examples with /ləʃáwʔ/ 'be taught'

SUBJECT	INCOMPLETEIVE	COMPLETIVE	POTENTIAL
SINGULAR	1 st /təʃáwʔ/	/nəʃáwʔ/	/nʔtəsáwʔ/
	2 nd /k'əʃáwʔ/	/k'əʃáwʔ/	/nʔk'əsáwʔ/
	3 rd /ləʃáwʔ/	/nəʃáwʔ/	/nəsáwʔ/
DUAL	1 st /təʃáwʔje/	/nəʃáwʔje/	/nʔtəsáwʔje/
	2 nd /təʃáwʔk'e/	/nəʃáwʔk'e/	/nʔtəsáwʔk'e/
	3 rd /ləʃáwʔje/	/nəʃáwʔje/	/nəsáwʔje/
PLURAL	1 st /təʃáwnən/	/nəʃáwʔnən/	/nʔtəsáwʔnən/
	2 nd /təʃáwʔk'en/	/nəʃáwʔk'en/	/nʔtəsáwʔk'en/
	3 rd /tətʃ ^h áwʔ/	/nətʃ ^h áwʔ/	/nʔtətʃ ^h áwʔ/

Finally, notice that the third person plural includes the [+sg] prefix.

7.3.1.5. Predicate adjectives

Many expressions that are characteristically expressed with adjectives in English are expressed with verbs in Northern Pame. This is always the case with the so called 'predicate adjectives'. The constructions for such meanings are identical to the T-N class morphology minus the palatal glide.

TABLE 7-12. Predicate adjective examples with /ləhín/ 'be happy'

SUBJECT	INCOMPLETE	COMPLETE	POTENTIAL
SINGULAR	1 st /təhín/	/nihín/	/n'təhín/
	2 nd /k'əhín/	/k'əhín/	/n'k'əhín/
	3 rd /ləhín/	/nəhín/	/nəhín/
DUAL	1 st /təhínse/	/nəhínse/	/n'təhínse/
	2 nd /təhínk'e/	/nəhínk'e/	/n'təhínk'e/
	3 rd /ləhínse/	/nəhínse/	/nəhínse/
PLURAL	1 st /təhínən/	/nəhínən/	/n'təhínən/
	2 nd /təhínk'e/	/nəhínk'e/	/n'təhínk'en/

7.3.2. *Additional verbal morphology*

In addition to the basic verb classes described in 7.1.2, there are several other categories that are summarized in this section, namely, modality, directionality, participle and imperatives. It is important to note that the suffixes 1, 2 and 3 all apply to these categories as well.

7.3.2.1. *Modality*

In addition to potential modality represented in the verbal morphology above, Northern Pame has the modality concept of 'realis', which expresses a certain future event. Realis is morphologically marked with the auxiliary verb attached to the potential stem.

(29) Future/Realis morphology

PERSON FUTURE/REALIS

1st /mɑ/

2nd /mɑ/

3rd /mɑ/

(30) Future/Realis Examples.

AUXILIARY	STEM (POTENTIAL)	STEM TYPE	FUTURE/REALIS PHRASE	
/mɑ/	/n'káts/	L-D class	/mɑ n'káts/	'you will set.soft'
/mɑ/	/nətsúʔ/	L-G class	/mɑ nətsúʔ/	'I will fall off'
/mɑ/	/n'p ^h én/	T-D class	/mɑ n'p ^h én/	'he will hit'
/mɑ/	/n'təts ^h áwʔ/	T-N class	/mɑ nʔtəts ^h áwʔ/	'they will learn'

7.3.2.2. *Directionals*

Concepts such as 'going to' and 'coming from' are expressed with the following auxiliary particles in addition to a directional prefix clitic roughly meaning 'at'.

(31) Directional morphology.

	'GOING TO'	'COMING FROM'	DIRECTIONAL CLITIC
1 st	/wɑ/	/ne/	/kɑ-/
2 nd	/wɑ/	/ne/	/kɑ-/

3rd /ma/ /ne/ /ga-/

(32) Directional morphology examples.

PREFIX	DIRECTIONAL	INCOMPLETIVE ROOT	DIRECTIONAL PHRASE	
/wa/	/ka-/	/táwn/	/wa ketáwn/	'I am going to buy'
/wa/	/ka-/	/táwn/	/wa ketáwn/	'you are going to buy'
/ma/	/ga-/	/táwn/	/ma getáwn/	'he is going to buy'
/ne/	/ka-/	/pá/	/ne kepá/	'I am coming to visit'
/ne/	/ka-/	/pá/	/ne kepá/	'you are coming to visit'
/ne/	/ga-/	/pá/	/ne gepá/	'he is coming to visit'

7.3.2.3. *Participles*

Participles in Northern Pame are formed by adding a participial prefix to the verb root.

(33) Participle morphology.

	SINGULAR	PLURAL
PARTICIPLE PREFIX	/me-/	/be-/

(34) Participle morphology examples.

PREFIX	VERB ROOT	STEM	
/mə-/	/ʔú/	/məʔú/	'dried'
/mə-/	/háw/	/məháw/	'good, well'
/mə-/	/læʔæ/	/məlæʔæ/	'living'
/bə-/	/túdet/	/bətúdet/	'dead.PI'
/bə-/	/ʔétʃ'/	/bəʔétʃ'/	'sold.PI'
/bə-/	/háw/	/bəháw/	'good, well.PI'

7.3.2.4. Imperatives

Imperatives are morphologically marked based on the transitivity of the verb. If the verb typically requires an object (transitive), it is marked with a palatal glide prefix plus a /-t/ suffix, which may be augmented for beneficiary/recipient as well as number with the suffix clitics already mentioned.

(35) Imperative morphology

	PREFIX	SUFFIX
IMPERATIVE (TRANSITIVE)	/j-/	/-t/
IMPERATIVE (INTRANSITIVE)	/k'ə-/	/-t/

TABLE 7-13. Transitive imperatives

PREFIX	ROOT	SUFFIX	STEM	
/j-/	/pǎhæ/	/-t/	/bíhæt/	'take it'
/j-/	/páhaw/	/-t/	/bíhaw/	'loan it'
/j-/	/náwn/	/-t/	/náwnt/	'eat it'
/j-/	/táwn/	/-t/	/tʃáwnt/	'buy it'
/j-/	/tʃéwl'/	/-t/	/tʃéwl'ət/	'close it'
/j-/	/sín/	/-t/	/ʃínt/	'open it'
/j-/	/kwæp/	/-t/	/tʃuwébət/	'return it'
/j-/	/ʔəts'/	/-t/	/rjəts'/	'sell it'
/j-/	/ʔat/	/-t/	/rjat/	'look for it'
/j-/	/háwʔ/	/-t/	/hjáwʔt/	'drink it'
/j-/	/hěw/	/-t/	/hjǐwt/	'pay for it'

Intransitive notions have the second person singular prefix without the palatal glide in addition to the imperatival suffix.

TABLE 7-14. Intransitive imperatives

PREFIX	ROOT	SUFFIX	STEM	
/k'ə-/	/púʔ/	/-t/	/k'əpúʔt/	'lower yourself'
/k'ə-/	/n ^h ǎs/	/-t/	/k'ən ^h ǎsət/	'stand up'
/k'ə-/	/n ^h éjʔ/	/-t/	/k'ən ^h étʃ' /	'enter'
/k'ə-/	/ruwǎ/	/-t/	/k'əruwǎt/	'walk'
/k'ə-/	/kěʔǎn/	/-t/	/k'əkěʔǎnt/	'pull'
/k'ə-/	/ʔéhəʎ' /	/-t/	/k'əʔéhəʎ'ət/	'sleep'

7.4. Conclusion

The morphology described here illustrates the preference of Northern Pame to mark person categories with prefixes, whether the base be verbal or nominal. This is probably the most consistent aspect of the language's morphological structure. Likewise, number is a very productive morpheme on nouns and verbs, with the one exception of the third plural of three verb classes. Here, the preference is to mark number as a prefix in the underlying form, yet very often with a surface autosegment of aspiration (see chapter 9 for more discussion). Finally, of the three person categories, the second person is clearly the most marked. This is seen, for example via the tone possession stems where the second person is always the opposite tone of the base, 1st and 3rd person forms. Also, the second person is usually the palatalized variant of the base in both verbs and nouns, although there are clear paradigmatic exceptions.

CHAPTER 8

MORPHOPHONEMICS

8.1. Introduction

Northern Pame morphophonemics entail a great deal of phonological alternations along the left edge of the grammatical word, where nominal person possessor and verbal tense, aspect, mode and person are morphologically marked. Morphophonemic alternations on the right edge of the word, although productive, are limited to issues regarding stem final glottal stops and deletion of onset consonants from number suffixes.

As will be discussed in this chapter, morphophonemic processes are typically associated with three types of phonological behaviors. The first covers those processes that are sensitive to place specifications such as palatalization and buccalization of laryngeal segments. The second are morphophonemic alternations of laryngeal articulations, which includes such processes as deaspiration, deglottalization and (under certain circumstances) devoicing. The third type of processes are those of consonant deletion and an allomorphic process for the dual suffix, both of which are discussed under the section of issues related to syllabification.

8.2. Palatalization

As previous chapters have illustrated, Northern Pame exhibits a tremendous amount of palatalization. There are three ways in which palatalization can be manifested, depending on the kinds of constraints involved: 1) metathesis of a palatal glide before a less sonorous consonant, 2) glide-consonant coalescence with the output segment being palatal, or 3)

vocalization of a palatal glide to /i/ just when a sequence of /C_[labial]ʔ/ or /C_[labial]h/ is involved.

TABLE 8-1. Three types of palatalization

PALATALIZATION	INPUT	OUTPUT	
A. GLIDE METATHESIS	/n-ʔj-púʔ/	[nʔpjúʔ]	'his butter'
	/n-ʔj-mæʔp/	[nʔmjæʔp]	'his donkey'
B. GLIDE-CONS COALESCENCE	/n-ʔj-t ^h úʔ/	[ntʃ ^h úʔ]	'his armadillo'
	/n-ʔj-k'éʃ/	[nʔtʃ'éʃ]	'his piece of paper'
	/n-ʔj-núwæ/	[nʔnúwæ]	'his guns'
C. VOCALIZATION	/n-ʔj-p ^h é/	[nʔp ^h í]	'his pig'
	/n-ʔj-phæ/	[nʔpíhæ]	'his cargo'
	/n-ʔj-mʔáj/	[nʔmíʔaj]	'his animal'

All of the examples in table 8-1 share the common element of a palatal glide prefix in the underlying form (in this case, the prefix for the 3rd person possessor) and one of the three mentioned types of palatalization in the output.

In the discussion that follows, it is claimed that the alternations found with the palatal glide are motivated primarily by the grammar's preservation of constraints related to two matters: a drive to maintain sonority sequencing and a tendency to disfavor the occurrence of adjacent identical features.

8.2.1. *Glide Metathesis*

Palatalization of the sort illustrated above assumes that an underlying glide exists as a

prefix. Although this is not an entirely self-evident assumption, the claim that these prefixes are in fact segmental palatal glides is supported by a fair amount of evidence. First, other sonorants such as nasals, laterals and the flap frequently appear in prefixes in surface data, as the data in table 8-1 (and throughout the dissertation) clearly illustrate. Words such as /n-t'ŭs/ 'house', /lɛ-ʃɔwʔ/ 'he learns' /rɛ-ʔmũhũjʔje/ 'our.Dl.squashes' all illustrate types of productive prefixes that contain sonorants. Furthermore, nasal onsets in prefixes surface are resyllabified as onsetless nuclei identical to a vowel, thus realigning the phonotactics of the language to well-formedness as the following forms illustrate (i.e. /n̩t' ŭs/ 'house', /m̩ʔáws/ 'sweetened').⁴⁷ On the other hand, with respect to the palatal glides, the approach taken here is that glides cannot be syllabified like other sonorants because such segments neither surface as onsets in prefixes nor are they syllabified as nuclei. Rather, they surface as palatalization in one of the instances illustrated in 8-1.

Furthermore, governing the surface shape of forms in Northern Pame is a fundamental notion within phonology, the sonority hierarchy (Selkirk 1980, Clements 1990), which states that within a given syllable more sonorous segments tend to form nuclei, while less sonorous segments will fall towards the syllable margins. In Northern Pame, the Sonority Sequencing Principle (SSP) is at risk of being violated in onsets (or coda) sequences of a glide followed by a consonant.

(1) Sonority Sequencing Principle (SSP) (Selkirk 1982)

⁴⁷ Periods (.) indicate syllable boundaries.

‘Syllables are made up of segments where in any given string, more sonorous segments are nuclei and less sonorous segments are margins.’

In order to preserve the SSP, a language has a number of alternatives at its disposal including processes such as segmental deletion, epenthesis or in the case of Northern Pame, metathesis. Metathesis can be thought of in two ways, 1) a violation of precedence structure, or 2) a violation of ‘generalized alignment’, which states that languages tend to ‘respect’ the grammatical edges of words with their prosodic structure. The approach taken here will refer to metathesis as a strictly segmental precedence violation summed up in the constraint Linearity-IO.

(2) LINEARITY-IO (LIN-IO) (McCarthy and Prince 1995)

‘The output reflects the precedence structure of the input and vice versa.’

(3) Ranking

SSP>>LIN-IO

(4) Glide metathesis

Input:	/nʔjpúʔ/	SSP	LIN-IO
a.	nʔ.jpúʔ	*!	
b.	nʔj.púʔ	*!	
c. 	nʔ.pjúʔ		*

In (4), the input has two prefixes attached to the lexical root (i.e. a classifier and a possessor). The surface phonotactics of Northern Pame can manage /nʔ/ as a well-formed VC syllable, where the nasal is the nucleus and the glottal stop a coda.

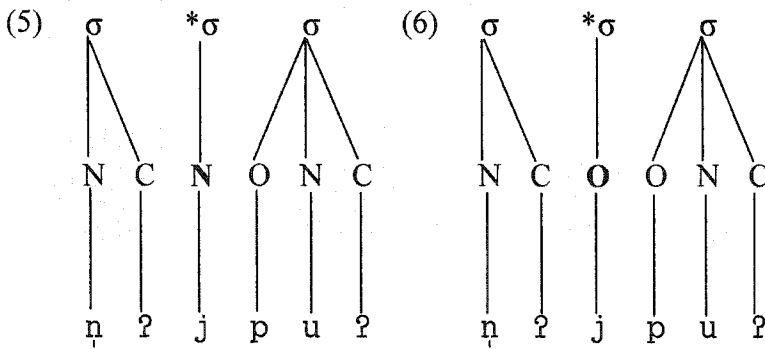

However, the palatal glide does not have the luxury of existing either as a coda or as an onset. In either case of $*nʔj]_{\sigma}$ (/j/=coda) or $*jpu]_{\sigma}$ (/j/=onset), the SSP is violated since a glide is more sonorous than either of the consonants it might be clustered with. Candidates (a) and (b) illustrate the faithful case where no precedent structure changes are

made, but the underlying sequence of segments is syllabified with /j/ as either a coda or an onset. In these two cases, the SSP is fatally violated. The preferred alternative in Northern Pame is to preserve the SSP, which is accomplished by metathesization of the glide with the following consonant /p/ (a violation of LIN-IO). This ordering places the glide in a more optimal, onset pre-nucleic position satisfying the SSP. Thus, candidate (c) is the winner.

8.2.2. *Glide-consonant coalescence*

Glide-consonant coalescence is a further consequence of glide metathesis, or rather, a violation of left alignment in order to preserve the SSP. As illustrated in chapter 5, a coronal or velar consonant adjacent to a palatal glide is forbidden according to the OCP, restated in (7).

(7) OCP

‘Adjacent segments are prohibited’

In order to preserve the OCP, a coronal or velar consonant is fused with an adjacent glide to form a single surface consonant. This is a violation of UNIF-IO, which forbids such mergers. The definition is restated in (8).

(8) UNIFORMITY-IO (UNIF-IO) (McCarthy and Prince 1995)

‘Output consonants must not have multiple input correspondents’.

The result is a ranking with the two markedness constraints, SSP and OCP, dominating two

faithfulness constraints, LIN-IO and UNIF-IO.

(9) Constraint Ranking

SSP, OCP >> LIN-IO >> UNIF-IO

(10) Glide-consonant coalescence

Input:	/n-ʔj-núwæ/	SSP	OCP	LIN-IO	UNIF-IO
a.	nʔ.jnú.wæ	*!			
b.	nʔ.njú.wæ		*!	*	
c. 	nʔ.nu.wæ			*	*

In (10), we see that the faithful candidate (a) does not satisfy the high ranking SSP. Candidate (b) is the metathesized alternate, which also fails due to a high ranking OCP violation. Candidate (c) goes one step further and violates the faithfulness constraint, UNIF-IO, exemplified in consonant coalescence. Candidate (c) wins by preserving the SSP and the OCP at the expense of two lower ranked faithfulness constraints.

8.2.3. *Glide-Vowel Coalescence*

In certain circumstances, metathesis of a glide suffix is not sufficient to produce an optimal surface form. Such a case occurs specifically when the UR has an initial root cluster of a consonant plus a laryngeal. It will be recalled that clusters such as /ph th kh/ are prohibited from surfacing and consequently epenthesis takes place to break up the cluster

giving us the laryngeally interrupted vowels discussed in chapters 4 and 5. Thus, a word such as [nmáhcw] ‘stomach’ has an underlying form /nmháw/ before the repair of the consonant cluster /mh/ takes place.

We see this pattern occur with roots prefixed with a palatal glide as well, with the exception that the epenthetic vowel no longer is a copy of the root vowel (such as /ahaw/ from /Vhaw/ from ‘stomach’). Rather, the vowel is a high front vowel /i/, or a vocalization of the glide prefix in conjunction with metathesis. Once again, the dominant constraint in motivating such a process is the SSP; in addition, the faithfulness constraint (LIN-IO) must be violated in order to remedy the glide in prefix position.

(11) Glide Metathesis with subsequent vocalization

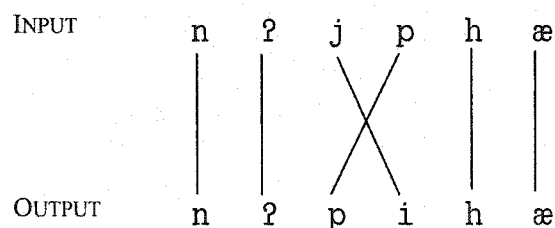

In addition to these, we will add the constraint in (12), which specifies the fact that laryngeals may not follow consonants in a consonant cluster.

(12) *Ch/ʔ

‘A cluster of a consonant plus a laryngeal is prohibited in the output.’

The constraint *Ch/? in turn dominates a faithfulness constraint preserving the consonantal specification for /j/, which is defined below as IDENT[cons].

(13) IDENT[cons]

‘Output segments have input correspondents for [cons].’

The final ranking of these four constraints is represented in (14), where the two markedness constraints *Ch/? , SSP are unordered relative to one another, but dominant the two unordered faithfulness constraints LIN-IO, IDENT[cons].

(14) Final ranking

*Ch/? , SSP >> LIN-IO, IDENT[cons]

(15) Glide vocalization

Input:	/n-ʔj-phæ/	*Ch/?	SSP	LIN-IO	IDENT[cons]
a.	nʔ.jphæ	*!	*		
b.	nʔ.pjhæ		*!	*	
c.	nʔ.phjæ	*!		**	
d. 	nʔ.pí.hæ			*	*

In (15) we see an input form with among other things, a palatal glide as a prefix marking 3rd person possessor. Candidate (a) has the illicit cluster /jph/, which fatally violates *Ch/? . At the same time, with /j/ in the same precedence structure as the input form, the SSP is also violated. Candidate (b) violates LIN-IO, which preserves *Ch/? , but fatally violates the SSP. Candidate (c) is a form that violates LIN-IO two times (i.e. metathesis over two segments), which satisfies the SSP, but fatally violates *Ch/? . Candidate (d), however, appeases both *Ch/? and the SSP /j/ to /i/ via vocalization and is the winner.

Other forms that involve the preservation of the SSP via metathesis of a glide are those roots that contain the vowel /e/ following a bilabial root onset. As illustrated above with forms such as /nʔpjúʔ/ ‘his butter’, it has been shown that a violation of LIN-IO alone will suffice in SSP preservation. However, where the root vowel is /e/ as in (16), vowel coalescence, an additional violation of the constraint UNIF-IO, must occur to accommodate this rather peculiar phonotactic constraint.

(16) Glide vocalization

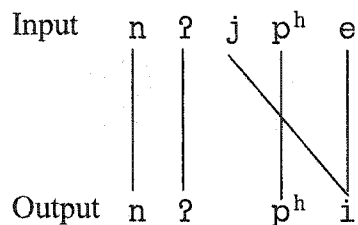

First, let us assume the familiar ranking of the SSP dominating LIN-IO as in (17).

- (17) Ranking
SSP >> LIN-IO

It is also necessary to stipulate the faithfulness constraint prohibiting aspirated palatalized labials as part of the underlying phonological inventory (18). Thus, the ranking in (17) must now include the subsequent ranking in (19).

- (18) */p^hj/
'Palatalized labials are prohibited.'

- (19) Ranking
SSP, */p^hj/ >> LIN-IO

However, the ranking in (19) will still not produce a candidate that agrees with the facts of the language, where the vocoid /i/ surfaces in the lexical root. This must involve a violation of UNIF-IO as a coalescence of /j/ and /e/. In order to motivate a violation of UNIF-IO, it is necessary to stipulate that front, non-low sonorants may not be articulated contiguously.

- (20) $*(+/-)H$
 ‘Contiguous front segments with [+high] and [-high] are prohibited.’

Looking at the distinctive features for Northern Pame vowels, we see that the only difference between /i/ and /e/ is the value for [high]. In this case, [+high] alone may surface, which is reminiscent of what we have seen with consonant coalescence during palatalization.

- (21) Vowel distinctive features

	/i/	/e/	/æ/	/ə/	/u/	/ɑ/
High	+	-	-	-	+	-
Low	-	-	+	-	-	+
Back	-	-	-	+	+	+

The ranking of these constraints is quite similar to that in (14), where both markedness and faithfulness constraints are unordered among themselves, but markedness dominates faithfulness.

- (22) Ranking
 $SSP, */p^h j/, *(+/-)H \gg LIN-IO, UNIF-IO$

(23) Vocalization/coalescence of /j/

Input:	/n-ʔj-p ^h é/	SSP	*/p ^h j/	*(+/-)H	LIN-IO	UNIF-IO
a.	nʔ.jp ^h é	*!				
b.	nʔ.p ^h jé		*!		*	*
c.	nʔp ^h jé			*!	*	
d.	nʔp ^h í				*	*

Looking at the tableau in (23), we see an underlying form that contains a palatal glide prefix and a root with an initial labial consonant followed by /e/. The candidate in (a) is in violation of the SSP with the glide unaltered in its surface form. Candidate (b) satisfies the SSP by violating both LIN-IO and UNIF-IO in the form of consonant coalescence. However, such a form is not attested in the underlying phonemic inventory of Northern Pame; this is a fatal violation of */p^hj/. Candidate (c) contains a segmental /j/ after the labial, but in so doing it is guilty of a violation of *(+/-)H. Candidate (d), invokes UNIF-IO while at the same time preserving */p^hj/. This is accomplished by vowel coalescence in place of consonant coalescence.

8.3. Buccalization and voicing of the feature [sg]

Aspiration, the attachment of the autosegment [+sg] to a consonant, is a common type of grammatical morpheme in Northern Pame. As seen in chapter 7, aspiration is the standard way to mark the third person plural of L-D verbs.

TABLE 8-2. [+sg] as a morpheme on L-D verbs

PROCESS	INPUT ⁴⁸	OUTPUT	
A. NONE	/ ^h -k ^h áts/	[k ^h wáts]	'they set soft'
	/ ^h -n ^h æhæp/	[n ^h æhæp]	'they run'
	/ ^h -sáwʔ/	[ts ^h áwʔ]	'they measure' ⁴⁹
B. LATERAL BUCCALIZATION	/ ^h -ʔátʃ/	[l ^h átʃ]	'they animal kick'
	/ ^h -héw/	[l ^h éw]	'they cure'
C. VOICING	/ ^h -pæ/	[bæ]	'they braid'
	/ ^h -pæʔæp/	[bæʔæp]	'they help him'

Typical cases of surface grammatical aspiration in Northern Pame occur on non-labial stops, affricates, nasals and fricatives, with the exception of the laryngeal fricative (A).⁵⁰ However, resistant to surface aspiration are the laryngeal consonants /h, ʔ/ and the labial stop /p/. In the case of the laryngeals, aspiration in the input surfaces as a laryngeally complex lateral (B), or in the case of the bilabial, aspiration becomes voicing (C).

⁴⁸ Person morphology /w-/ has been excluded for simplification. Its presence or absence has no direct consequences for the discussion at hand.

⁴⁹ There is an asymmetry with the affricates /ts/, /ts^h/ and /ts'/. Rather than the plain /ts/ + [+sg] surfacing as /ts^h/, we have /ts'/ as in the forms ts'ú 'they scold' and ts'éʔet 'they take animal'. However, /s/ + [+sg] does in fact surface as /ts^h/ as in 'measure'. The only conceivable explanation for this pattern is that historically, Northern Pame only had contrasts between glottalized alveolar-apical affricates and aspirated alveolar fricatives, which have been preserved in this paradigm. Examples of this pattern are relatively few in number and could conceivably be completely lexicalized.

⁵⁰ Roots beginning with /s/ have a slight coronal articulation, deriving an apical-coronal affricate.

8.3.1. *Lateral buccalization of [sg]*

Lateral buccalization, the assignment of [+lat, +cor] to the aspiration feature, although odd in appearance, has some phonological motivation if we consider the alternatives. The primary problem with the underlying forms in (b) from table 8-2 is that there is a laryngeal morpheme in the form of the feature [+sg] that in the case with stops, surfaces as aspiration on the first root consonant. Aspirated laryngeal fricatives are phonetically implausible as probably are aspirated glottal stops. Thus, the aspirated laryngeal candidate is doomed from the start.

Another point to consider is the feature geometry representation of laryngeal features. This analysis follows Lombardi (1994) in assuming that the presence of laryngeal features [+sg], [+cg], [+vce] and other non-modal voice phenomena require the presence of the phonological laryngeal node, while plain voiceless segments have no laryngeal node at all. This has the advantage of being able to make a claim that segments with adjacent laryngeal nodes are marked, at least with respect to consonants; that is to say, [+sg], [+cg] and [+vce] rarely co-occur

Under this assumption the concatenation of [+sg] to either /h/ or /ʔ/ will be a violation of OCP(Lar).

(24) OCP(Lar)

‘Adjacent Laryngeal nodes are prohibited’.

Therefore, the grammar Northern Pame avoids violations of OCP(Lar) by optimizing the

input through a process of buccalization.

Current theoretical and typological findings would lead one to believe that the default place of articulation in a buccalization process is coronal (Prince and Smolensky 1993, Payne 1981).⁵¹ Thus, we might expect to see these laryngeals surface as a coronal stop.

(25) IDENT[cor]

Output segments have input correspondents for the feature [cor].'

(26) Provisional Ranking

OCP>>IDENT[cor]

(27) Incorrect buccalization with a coronal stop.

Input:	$^h\text{-}\text{p}'\acute{\text{a}}\text{t}\text{ʃ}$	OCP(Lar)	IDENT[cor]
a.	$\text{p}^h\text{'}\acute{\text{a}}\text{t}\text{ʃ}$	*!	
b. ☹️	$\text{t}'\acute{\text{a}}\text{t}\text{ʃ}$		*

However, looking at (27) we see that the winner (b) is incorrect. This is due to the important distributional fact that Northern Pame disallows laryngeally complex bilabial stops or alveolar stops word initially.

⁵¹ The violability of [cor] is expressed in OT as *Lab,*Dor>>*Cor and has had empirical support by looking at consonant epenthesis. This research has adapted these context-free markedness constraints to a low ranking of feature faithfulness constraints in the form of IDENTITY, which specifies that the value for [cor] is violable before other place features.

(28) *#P,T(Lar)

'Laryngeally complex /p, t/ are prohibited word initially'.

Therefore, the language must search for an optimal candidate that is coronal, but is not a stop.⁵² The lateral is the next best choice.

(29) Ranking

OCP(Lar),*#P,T(Lar)>> IDENT[lat, cor]>>IDENT[cor]

(30) Lateral buccalization with a glottal stop root.

Input:	$h-ʔáʔ$	OCP	*#P,T(Lar)	IDENT[lat, cor]	IDENT[cor]
a.	$ʔ^h áʔ$	*!			
b.	$t' áʔ$		*!		*
c. \mathcal{P}	$l' áʔ$			*	

⁵² Nasals and the flap likewise are never winners in this scenario. This analysis assumes that these features must be ranked above [lat] and therefore preserved.

(31) Lateral buccalization with a laryngeal fricative root.

Input:	h ^h -héw	OCP	*#P,T(Lar)	IDENT[lat,cor]	IDENT[cor]
a.	h ^h éw	*!			
b.	t ^h éw		*!		*
c. 	l ^h éw			*	

In tableau (30), the input has a root with an initial glottal stop, which has the plural morpheme [+sg]. Candidate (a) fatally violates high ranking OCP(Lar), and candidate (b) does the same to *#P,T(Lar) in an attempt to change its coronal value. Only candidate (c) preserves both markedness constraints, but at the added featural change for lateral.

The input in example (31) is compared with the faithful candidate (a), but this candidate violates the OCP(Lar). Candidate (b) is an attempt to buccalize with a plain coronal stop, but is unsuccessful for language specific markedness reasons (28). Candidate (c) is the optimal candidate in that it preserves OCP(Lar), while also allowing for a surface form of the plural morpheme [+sg].

8.3.2. Voicing of [sg]

When a voiceless bilabial stop is affixed with aspiration, the surface form is always a voiced bilabial stop. That is, aspirated voiceless bilabial stops are non-existent in word initial position, but always neutralize with bilabial stops. We have already established the language-specific markedness constraint (28) to account for this idiosyncrasy. However, the question remains as to how to explain this alternation with voice in a principled way.

First, the fact that voiceless bilabial stops would be singled out to alternate with voice has articulatory support (Lisker and Abramson 1964, Pickett 1999). A voiced stop requires two gestures: 1) the occlusion of air flow by some oral articulator and 2) near-simultaneous vocal fold vibration. The release of a stop is the effect of air pressure built up from egressive airflow pushing against the oral occlusion. This pressure takes longer to build up for labial consonants compared to velars, due to a longer vocal chamber. Because of this longer duration pressure build up, voicing is most optimal with labials and least so with segments articulated further back in the vocal tract such as velars or uvulars. The preference for voiced bilabials over voiced non-bilabials can be explained by ranking a faithfulness constraint for bilabial voice below that of non-labial stops. The constraint is given in (32) followed by a ranking in (33).

(32) IDENT:P[vce]

‘Output /p/ segments have input correspondents for [vce]’.

(33) Ranking of voicing markedness

IDENT:K[vce]>>IDENT:T[vce]>>IDENT:P[vce]

The ranking in (33) says that the value of voice for a voiceless bilabial stop is more violable than the value for voice among non-bilabials (e.g. coronals and velars).

Taking this approach toward bilabial stop voicing, we can integrate (32) into the ranking given for lateral buccalization in (29) to produce the final ranking in (34).

(34) Ranking of bilabial voicing with other feature faithfulness constraints.

OCP(Lar), *#P,T(Lar)>>IDENT[lat, cor]>>IDENT[cor]>>IDENT:P[vce]

The low ranking of IDENT:P[vce] predicts that voicing for a bilabial will be preferred over a form that is the output of the buccalization process.

(35) Voicing of bilabial stops when [sg] is present word initially.

Input:	/ ^h -pæ/	OCP	*#P,T(Lar)	IDENT[lat,cor]	IDENT[cor]	IDENT:P[vce]
a.	p ^h æ		*!			
b.	l ^h æ			*!		
c.	t ^h æ		*!		*	
d. 	bæ					*

The input has a root with an initial bilabial stop affixed with [+sg]. The faithful form in candidate (a) would be preferred if it were not for the presence of high ranking *#P,T(Lar). Candidates (b) and (c) both fail because the IDENTITY constraints involved in those processes are more 'expensive' than the violation of IDENT:P[vce] for candidate (d). Thus, (d) is the winner.

8.4. Coronal lateralization

The constraint *#P,T(Lar) manifests itself frequently among word-initial aspirated

coronal stops whether they are lexically or morphologically based.

TABLE 8-3. Lexical and morphological inputs for lateralization

ASPIRATION TYPE	INPUT	OUTPUT	
A. LEXICAL	/j-t ^h áħaw/	[ʌ ^h áħaw]	'jobs'
	/j-t ^h ūwǎ/	[ʌ ^h ūwǎ]	'corn seeds'
	/j-t ^h ús/	[ʌ ^h ús]	'salts'
	/j-t ^h ǎhǎe/	[ʌ ^h ǎhǎe]	'influenzas'
B. MORPHOLOGICAL	/ ^h -tǎhǎp/	[l ^h ǎhǎp]	'they collect'
	/ ^h -táħaw/	[l ^h áħaw]	'they work'
	/ ^h -tuǎn/	[l ^h uǎn]	'they break it'

Regardless of their morphological input status, word-initial coronal stops always lateralize as the tableaux in (36) and (37) illustrate.⁵³

(36) Lateralization or lexical inputs with /t^h/.

Input:	/j-t ^h ús/	*#P,T(Lar)	IDENT[lat,cor]	IDENT[cor]
a.	t ^h jús	*!		*
b.	ʌ ^h ús		*	

⁵³ For the sake of simplicity this research has not included the full tableau that involves palatalization with the candidates in (26). The reader will find this process described in detail in 8.1.1.1.

(37) Lateralization of morphological inputs with /t^h/.

Input:	/ ^h -tuæ̃n/	*#P,T(Lar)	IDENT[lat,cor]	IDENT[cor]
a.	t ^h uæ̃n	*!		*
b.	l ^h uæ̃n		*	

8.5. Glottal buccalization

There exists an allophonic variation among glottalized nasals that occurs only during morphological prefixation. Specifically, a glottalized nasal will allophonically change to a post-stopped nasal when before a bilabial or palatal glide.

TABLE 8-4. Buccalization of [cg] on nasal consonants

INPUT	OUTPUT	
a. /n-m'ú/	[nm'ú]	'cactus'
b. /n-ʔw-m'ú/	[nʔm̃bú]	'my cactus'
c. /n-ʔj-m'ú/	[nʔm̃bjú]	'his cactus'
d. /n-n'éw/	[nn'éw]	'thirst'
e. /n-ʔw-n'éw/	[nʔñd'éw]	'my thirst'
f. /n-ʔj-n'éw/	[nʔñdíw]	'his thirst'
g. /j-m'æ/	[m̃bjæ]	'beds'
h. /j-m'áʔαj/	[m̃bjáʔαj]	'animals'
i. /j-m'ú/	[m̃bjú]	'cacti'

This can be seen with either glottalized bilabial nasals or their alveolar counterparts.

In order to account for this allophony, let us begin by postulating a constraint prohibiting glottalized nasal consonants before a glide in the context-sensitive markedness constraint in (38).

(38) *m'G

‘glottalized sonorants are prohibited before glides.’

Next, a context-free markedness constraint is included prohibiting post-stopped nasals.

(39) *m̂b

‘Post-stopped nasals are prohibited.’

Finally, there is a faithfulness constraint preserving the glottalization of glottalized nasals in (40).

(40) IDENT:M[cg]

‘Output segments have input correspondents for [cg].’

These three constraints are summarized in the ranking in (41).

(41) Ranking

*m'G >> *m̂b >> IDENT:M[cg]

This ranking predicts that if a glottalized nasal+glide cluster is in the input, it will fail due to *m'G. The next best choice is the post-stopped nasal. If the input is a glottalized nasal without a following glide, then IDENT:M[cg] will not be violated and the candidate faithful to the input will win.

(42) Allophonic buccalization of glottalized nasals.

Input: /n-ʔj-m'ú/	*m'G	*m̂b	IDENT:M[cg]
a. nʔm'jú	*!		
b. nʔm̂bjú		*	*

In (42), the input has a morphological structure reminiscent of possessive nouns with a J-class prefix. Because the glide must metathesize, any surface form will have a glide following the root-initial glottalized nasal. Candidate (a) is the faithful form which fails due to a violation of high ranking *m'G. Candidate (b) wins by violating the lesser ranked *m̂b. Since *m̂b will be violated only when competing with *m'G, this is a purely allophonic representation.

(43) No buccalization takes place.

Input:	/n-m'ú/	*m'G	*m̂b	IDENT:M[cg]
a.	/nm'ú/			
b.	/nm̂bú/		*!	*

The final example in (43) illustrates the elsewhere principle in this allophonic variation. Here, (a) will win since *m'G is not at risk. Thus, the faithful form is the optimal candidate.

8.6. Consonant delaryngealization

A root-initial aspirated consonant exhibits three types of alternations when prefixed by the aspirated nasal for the 1st and 2nd person of the n/h class of possessive morphemes.

TABLE 8-5. Three types of delaryngealization

PROCESS	INPUT	OUTPUT	
A. Deaspiration	/n ^{-h} -p ^h úhu/	[n ^h púhu]	'my chair'
	/n ^{-h} -p ^h ǔhu/	[n ^h pǔhu]	'your chair'
B. Deglottalization	/j ^{-h} -t̚s'ěʔ/	[^h t̚ʃěʔ]	'my teeth'
	/j ^{-h} -t̚s'éʔ/	[^h t̚ʃéʔ]	'your.sg. teeth'
C. Deglottalization-devoicing	/n ^{-h} -m'áhaw/	[npáhaw]	'my stomach'
	/n ^{-h} -m'ǎhaw/	[npǎhaw]	'your stomach'

A root beginning with an aspirated stop will surface as unaspirated (a-b), while a glottalized consonant in similar fashion will lose its glottalization (c-d). However, if a glottalized nasal

is prefixed with an aspirated nasal, the glottalized nasal will neutralize to an unaspirated voiceless stop (e-f).

8.6.1. *Deaspiration*

Dealing with the case of deaspiration first, this analysis assumes that this is yet another effect of the constraint OCP(Lar): Northern Pame disallows two aspirated consonants to be contiguous and therefore, prefers an output in which it appears that some change has occurred.

Basically, the OCP(Lar) is similar to that regarding lateralization of [sg]. Recall in that analysis that the optimal candidate did not contain a deletion of the grammatical morpheme, a violation of MAX-IO. The faithfulness of non-lexical affixes is a common theme in Northern Pame and is applicable here as well.

Thus, we can make a distinction of the laryngeal node on a lexical consonant versus a non-lexical one. These are defined in (44) and (45).

(44) IDENT:C(Lar)_{lex}

‘Lexical output segments have input correspondents for (Lar)’.

(45) IDENT:C(Lar)_{-lex}

‘Non-lexical output segments have input correspondents for (Lar)’

These faithfulness constraints are ranked so that the laryngeal node for lexical consonants will be phonologically altered before non-lexical ones.

(46) Ranking

OCP >> IDENT:C(Lar)_{-lex} >> IDENT:C(Lar)_{lex}

(47) Deaspiration of lexical stops.

Input:	n ^{-h} -p ^h úhu	OCP	IDENT:C(Lar) _{-lex}	IDENT:C(Lar) _{lex}
a.	n ^h p ^h úhu	*!		
b.	np ^h úhu		*!	
c. ↵	n ^h púhu			*

In (46), the input has two adjacent aspirated consonants. Candidate (a) fails due to a violation of OCP(Lar), and candidate (b) likewise fails because the surface form deletes aspiration from the non-lexical consonant. Candidate (c), therefore, wins by deaspirating the lexical consonant according to the minimal violation of IDENT:C(Lar)_{lex}.

8.6.2. Deglottalization

The deletion of the laryngeal node is applicable in exactly the same way where an aspirated consonant prefixes to a glottalized consonant. Again, the surface form has a preserved non-lexical laryngeally complex segment, but a delaryngealized (i.e. deglottalized) lexical consonant.⁵⁴ This is accomplished by delinking the lexical consonant from the laryngeal node.

⁵⁴ Palatalization constraints have been omitted since they are explained elsewhere.

(48) Deglottalization

Input:	$j^h\hat{t}s'ě?$	OCP	IDENT:C(Lar) _{-lex}	IDENT:C(Lar) _{lex}
a.	$j^h\hat{t}s'ě?$	*!		
b.	$j\hat{t}s'ě?$		*	
c. 	$j^h\hat{t}sě?$			*

8.6.3. Deglottalization-devoicing

Finally, glottalized nasals will neutralize to a voiceless stop when contiguous to an aspirated consonant. Following the same reasoning as above, we argue that the OCP(Lar) prohibits such an underlying form to surface. Likewise, the least minimal faithfulness constraint that can be violated is the *lexical* consonant rather than the non-lexical one. However, the optimal candidate is not a plain nasal as we might expect.

(49) Incorrect tableau for nasal deglottalization-devoicing.

Input:	$/n^{-h}-m'áhw/$	OCP	IDENT:C(Lar) _{-lex}	IDENT:C(Lar) _{lex}
a.	$n^hm'áhw$	*!		
b.	$nm'áhw$		*	
c. 	$n^hmáhw$			*

The reason for this apparent discrepancy lies in our fundamental definition of a nasal consonant with relation to laryngeal features. Under the analysis proposed here, all active

laryngeal features imply the presence of a laryngeal node, while voiceless segments have no laryngeal node at all. Thus, plain nasal consonants are still voiced and therefore, their feature-geometry representation includes a laryngeal node. Therefore, an aspirated nasal followed by a plain (voiced) nasal will constitute a violation OCP(Lar) and subsequently, will cause the *delinking* of the laryngeal node from the plain nasal.

Thus, we can apply a context-free markedness constraint that prohibits plain nasals from being detached from the laryngeal node.⁵⁵

(50) *N(-Lar)

‘Nasal consonants without a laryngeal node are prohibited’.

The ranking in (51) includes *N(-Lar) as well as a low-ranked faithfulness constraint preserving the value for nasal. This constraint must be sufficiently low as to be violated instead of *N(-Lar).

(51) Ranking

OCP, *N(-Lar) >> IDENT:C(Lar)_{-lex} >> IDENT:C(Lar)_{lex}, IDENT[nas]

⁵⁵ One natural consequence of this approach is the feature geometry structure of voiceless nasals. It is assumed that voiceless nasals and aspirated nasals have no distinction. This implies that voiceless nasals *must* be represented with a laryngeal node and a terminal feature [+sg]. For more discussion see Lombardi (1994)

(52) Delaryngealization of glottalized nasals.

Input: /n ^h -m ^h -m' áhaw/	OCP	*N(-Lar)	IDENT:C(Lar) _{lex}	IDENT:C(Lar) _{lex}	IDENT [nas]
a. n ^h m' áhaw	*!				
b. nm' áhaw			*!		
c. n ^h máhaw		*!		*	
d. npáhaw				*	*

In (52), the input has a consonant cluster of an aspirated nasal followed by a glottalized nasal. Such a combination is ill-formed in Northern Pame and is therefore ruled out in the form of candidate (a), the faithful form. Candidate (b) also fails by the familiar violation of the non-lexical consonant rather than the lexical one. Candidate (c) deglottalizes the lexical nasal as needed, but the result is incorrect based on the context-free markedness constraint *N(-Lar) and therefore, also fails. Candidate (d) is the winner by not only deglottalizing the lexical consonant via the delinking of the laryngeal node, but also by correctly representing it as a voiceless stop, the only possible segment that can be bilabial while being unlinked to a laryngeal node.

8.6.4. *Glottal stop voicing*

Another issue related to laryngeal articulations is that of glottal stop voicing.

TABLE 8-6. Glottal stop voicing

	PROCESS	INPUT	OUTPUT	
a.	voicing	/təʔséʔde/	[təʔséede]	'we.Dl. take them'
b.	voicing	/gəʔtsáʔdət/	[gəʔtsáadət]	'they drowned'
c.	voicing	/manəkáwʔdət/	[manəkáw:dət]	'they will rest'
d.	voicing	/aʔsúʔdət/	[əʔsúudət]	'they fall off'
e.	voicing	/ləʔmǝʔbət/	[ləʔmǝebət]	'they joined 'them'
f.	voicing	/manʔʔsúʔnən/	[manʔʔsúunən]	'we will fall it'

A glottal stop is prohibited from surfacing if contiguous to a voiced segment. In such cases, it will surface as a voiced segment.

First, let us assume a context-sensitive markedness constraint prohibiting glottal stops before voiced consonants.

(53) *ʔC_[+vce]

'Glottal stops before voiced consonants are prohibited'.

In addition, two faithfulness constraints are listed, which specify voicing values for either a lexical or non-lexical consonant.

(54) IDENT:C[vce]_{lex}

'Lexical output segments have input correspondents for the feature [vce]'.

(55) IDENT:C[vce]_{-lex}

'Non-lexical output segments have input correspondents for the feature [vce]'.

The ranking in (56) reflects the order of markedness dominating faithfulness and likewise, non-lexical segments dominating lexical ones.

(56) Ranking

* $\mathcal{P}C_{[+vce]}$ >> IDENT:C[vce]_{-lex} >> IDENT:C[vce]_{lex}

(57) Glottal stop voicing.

Input: /tət̪séʔde/	* $\mathcal{P}C_{[+vce]}$	IDENT:C[vce] _{-lex}	IDENT:C[vce] _{lex}
a. tət̪séʔde	*!		
b. tət̪séʔte		*!	
c. [☞] tət̪seéde			*

Candidate (a) in (57) is sub-optimal with * $\mathcal{P}C_{[+vce]}$ being violated. Candidate (b) loses because the voicing of the non-lexical segment is changed. Instead, the lexical segment, the glottal stop, must be voiced.

8.7. Conclusion

Northern Pame morphophonemics illustrate a variety of phonological phenomena that to some extent are predictable by well known phonological constraints, while to a lesser extent appeals to constraints that appear to be quite language specific. Regarding the former, we see for example the wide application of the SSP in consonantal metathesis, consonantal palatalization and vowel coalescence. Furthermore, the OCP(Lar) is quite productive any time two left word edge laryngeally complex consonants are contiguous. The OCP(Lar) is responsible for a general simplification of lexical root segments via the delinking of the laryngeal node and the consequential preservation of complex morphological segments. Likewise, it is shown that a strict syllable constraint allowing only nasal and glottal stop codas is in force by causing consonant deletion among consonant initial suffixes. More idiosyncratic to the language is its disposition against aspirated bilabial and coronal stops and the consequences this constraint invokes with processes such as lateralization of stops and even [+sg].

CHAPTER 9

CONCLUSION

9.1. Introduction

Northern Pame exhibits a wide variety of descriptive facts including a large segmental inventory of consonants and preference for a high amount of inflectional morphology. In addition, the tacit knowledge of the speaker-hearer of Northern Pame is partially captured in this research by the ranking of markedness versus faithfulness constraints within the paradigm of Optimality Theory. The following discussion summarizes the essential findings explained in detail in the previous seven chapters. Likewise, a number of residual issues that require further research are provided.

9.2. Results of the research

From a phonetics perspective, this research has provided acoustic support for Avelino's (1997) claim of a laryngeally complex consonantal system in Northern Pame. In addition, the claim is made in favor of the consonantal segmentation put forth by Avelino, with the one qualification that palatalized bilabial consonants are better interpreted as a sequence of a bilabial plus a palatal glide. Additionally, labialized velars as well as labialized and palatalized laryngeals should be regarded as consonant clusters rather than complex segmental units.

On the topic of laryngeally ambiguous vowels, it has been demonstrated that

Northern Pame contains roots with a VhV or VʔV, where both vowels flanking the laryngeal are always the same. Although these sequences are interpreted as laryngeally complex vowels in other Otomanguean languages such as Trique and Mazatec, evidence from syllabification, tonal alternations and epenthesis of /Ch/ or /Cʔ/ clusters suggest that VhV or VʔV consist of a segmental sequence of a vowel-laryngeal-vowel. Finally, an argument is made against the claim that Northern Pame has three tones: high, low and falling (Avelino 1997). Rather, it is claimed that only two tone contrasts exist: 1) a high tone, and 2) a rising tone. Primary evidence for this is a process of compensatory lengthening that is caused by a rising tone, but which is precluded over laryngeally ambiguous vowels.

Northern Pame is shown to have complex onsets and codas, albeit with strong restrictions. These include the high ranking of the OCP which forces anti-coalescence and anti-deletion faithfulness constraints to be violated. Additionally, no complex nuclei are allowed illustrating the dominance of *COMPLEX-N. Likewise, Northern Pame illustrates a process of denasalization of nasal codas just when they follow an oral vowel motivated by the high ranking constraint *VN.

Complex codas also exist in Northern Pame, but with severe restrictions such as the dominance of the Coda Condition on nasal place and intrusive stop formation of /t/ between /ʔs/ clusters. Likewise, velar suffixes have a special status of being resistant to palatalization, while their mirror image onset clusters have no such status. This is explained as the preservation of the morphological character of the suffixes, while velar onsets are purely lexical.

Northern Pame laryngeally ambiguous vowels are best understood as two phonological vowels bifurcated by a laryngeal segment. In addition to the distributional evidence in given in chapter 4, the results from a laryngealscopic examination also suggest that these laryngeals are articulated as ordinary laryngeal consonants.

A great deal of Northern Pame morphology is documented for the first time in this research. The morphology of Northern Pame nouns is shown to have a prefixal system for noun class, possession and number (in the case of N-class nouns). Suffix morphology includes notions for association, possessor number and number for non-possessed nouns. The verbal system in Northern Pame can be broken into two major morphological classes labeled here as either the L-class or the T-class. Likewise, these two classes contain two sub-classes based on transitivity. Other verbal morphology such as modality and imperatives are also included.

Northern Pame morphophonemics exemplify two major ways of conditioning a lexical root onset when combined with a prefix: 1) place conditioning (palatalization, buccalization of [spread glottis], lateral buccalization and glottal buccalization of glottalized nasals), 2) laryngeal conditioning (consonant delaryngealization, deaspiration, deglottalization, devoicing and glottal stop voicing).

9.3. Residual issues

Northern Pame bilabial consonants have a privileged place in the grammar by not behaving exactly like other consonants under certain morphological conditions. This has been illustrated with deletion (*DEP), for example when a word ending in /w/ is suffixed with /p/ (i.e. /ʃiŋkjǽwp/[ʃiŋkjǽp] 'his rat'). The result is a deletion of /w/.

Another pattern exists where a verb root with a bilabial onset will dorsalize to /g/ when previous to a (metathesized) /w/, just when the bilabial is non-word initial. In the following example in table 9-1, the root begins with /p/ and is part of the L-D verb morphology class.

TABLE 9-1. Dorsalization examples

SUBJECT		INCOMPLETEIVE	COMPLETIVE
SINGULAR	1 st	/lɛpǎ/	/nɛgwǎ/
	2 nd	/k'ɛpǎ/	/nɛbjǎ/
	3 rd	/pǎ/	/dɛgwǎ/
PLURAL	3 rd	/bǎ/	/dɛbǎ/

Notice that the first person completeive and the third person completeive illustrate dorsalization. What is evident is the morphological addition of /w/, which occurs with velar stop roots in the same paradigm (i.e. /kwǎʔs/ 'he sets.soft', /dɛkwǎʔs/ 'he set.soft'). Thus, a purely mutation approach cannot be correct (see Avelino 1997: 126). However, the fact that this dorsalization in the 3rd person plural forms is blocked by the voicing of [sg] requires further explanation.

Data exist in Northern Pame that suggest a process at work known as rhinoglottophilia (Matisoff 1975). Specifically, an allophonic homorganic nasal consonant will surface between a glottal stop coda and a non-laryngeally complex obstruent.

TABLE 9-2. Rhinoglottophilia examples

INPUT	OUTPUT	
/r-ʔj-pjújʔ/	[rəʔmpjújʔ]	'his butters'
/r-ʔw-t̃sáwʔt/	[rəʔnt̃sáwʔt]	'my sugars'
/r-ʔj-t̃ʃún/	[rəʔnt̃ʃún]	'his flowers'
/r-ʔw-tún/	[rəʔntún]	'my flowers'
/r-ʔw-kás/	[rəʔŋkwás]	'my cows'
/r-ʔj-sí/	[rəʔnʃí]	'his shoulders'
/rəʔt ^h úʔdət/	[rəʔt ^h úudət]	'my armadillos'

Rhinoglottophilia is a phenomenon where nasalization frequently occurs in the environment of laryngeal segments. The articulatory evidence for rhinoglottophilia is seen in that when a laryngeal is produced, the degree of closure of the velum is negligible to the perception of the laryngeal. Likewise, there is no aerodynamic requirement for velar closure in the production of a laryngeal (Matisoff 1975: 272).

The case at hand in table 9-2 is interesting in that nasal epenthesis is blocked from occurring between a glottal stop and a laryngeally complex obstruent such as the juncture between /ʔ/ and /t^h/ in /rəʔt^húudət/ [rəʔt^húudət] 'my armadillos'.

A final topic that requires further investigation is that of the areal similarities that certain data suggest exists between Pame and its neighboring languages Huasteco (Mayan)

and Huastecan Náhuatl (Utoaztecan)⁵⁶. For example, the proliferation of aspirated and glottalized obstruents in Otopamean is not characteristic of the Otomanguean language family, although such a distinction is commonplace among Mayan languages. The close proximity between these Pame and Huasteco within the Huasteca region may have allowed for the borrowing of laryngeally complex consonants. There appears to be no documentation of the causal influences that Huasteco may have on Pame.

Similarly, it is possible that Huastecan Náhuatl and Pame share common linguistic elements that are phonological in nature. One example is the neutralization of the vowels /i/ and /e/ in word-final, post-stressed position. In Northern Pame, we see this neutralization in all of the dual suffix forms in words such as the following.

- | | | | |
|-----|---------------|-----------------------------|---------------------------|
| (1) | /nʔtʃ'ésje/ | [nʔtʃ'ésje]~[nʔtʃ'ésji] | 'their.Dl piece of paper' |
| | /rəʔmũhũjʔje/ | [rəʔmũhũjʔje]~[rəʔmũhũjʔji] | 'our.Dl squashes' |
| | /tʃágwe/ | [tʃágwe]~[tʃágwi] | 'we.Dl.' |

In any post-stressed position, the contrast between /i/ and /e/ becomes lost, a fact which is further supported by the difficulty of native speakers to distinguish these vowels in literacy materials.

We see the same neutralization occur in Huastecan Náhuatl, where stress is predictable on penultimate syllables. Any Náhuatl high or mid front vowel will be

⁵⁶ The word *Huasteco/an* refers to the region where these languages are spoken, 50 miles east of the Pame region, and not to their family lineage.

pronounced as /e/ on an ultimate syllable.

- (2) /tetsistle/ [tetsistle]~[tetsistli] 'egg'
/tlaʃkale/ [tlaʃkale]~[tlaʃkali] 'tortilla'
/matsatle/ [matsatle]~[matsatli] 'pineapple'

It is still unclear how far such similarities go in providing evidence of phonological borrowing between Náhuatl and Pame. Such a hypothesis requires further data from both languages.

REFERENCES

- Anderson, Stephen R. 1975. The description of nasal consonants and internal structure of segments. *Nasálfest: Papers from a symposium on nasals and nasalization*, ed. by C.A. Ferguson, L.M. Hyman, and J.J. Ohala, pp. 1-26. Stanford: Stanford University Press.
- Avelino Becerra, Heriberto. 1997. *Fonología y morfofonología del Pame Norte*. México: Escuela Nacional de Antropología e Historia, Tesis.
- . 2002. Sandhi tonal en Pame Norte. *Del Cora al Maya Yucateco: estudios lingüísticos sobre algunas lenguas indígenas*, ed. by Paulette Levy, 17-58. Mexico: UNAM
- Barnitz, J.G. 1974. Bloom-p-field, Chom-p-sky, and phonetic epen-t-thesis. *Studies in the Linguistic Sciences* 4:1-13.
- Barthololmew, Doris. 1965. *A reconstruction of Otopamean (Mexico)*. Chicago: University of Chicago, Ph.D. Dissertation.
- . 1975. Some morphophonemic rules in Mazahua. *International Journal of American Linguistics* 41:293-305.
- Berthiaume, Scott. 2000. *Nasalization in Northern Pame*. University of Kansas Working Papers in Linguistics 25:137-52.
- Bhat, D.N.S. 1975. Two studies on nasalization. *Nasálfest: Papers from a symposium on nasals and nasalization*, ed. by C.A. Ferguson, L.M. Hyman, and J.J. Ohala, 27-48. Stanford: Stanford University Press.
- Blevins, Juliette. 1995. The syllable in phonological theory. *The handbook of phonological theory*, ed. by John A. Goldsmith, 206-44. Cambridge: Blackwell.
- Burquest, Donald A. and David L. Payne. 1993. *Phonological analysis: a functional approach*. Dallas: Summer Institute of Linguistics.
- Chan, M. K-M. 1987. *Post-stopped nasals in Chinese: an areal study*. UCLA Working Papers in Phonetics 68:73-119.
- Chemin, Dominique. 1993. *Imagen Pame Xi'oi*. San Luis Potosí: Archivo Histórico del Estado.
- Chemin-Bässler, Heidi. 1984. *Los Pames Septentrionales de San Luis Potosí*. Serie de Investigaciones Sociales (13). San Luis Potosí: Instituto Nacional Indigenista.
- Chomsky, Noam. 1957. *Syntactic structures*. The Hague: Mouton & Co.
- . 1966. *Aspects of the theory of syntax*. Cambridge: MIT press.

- , and Morris Halle. 1968. *The sound pattern of English*. New York: Harper and Row.
- Clark, John, and Colin Yallop. 1995 (second edition). *An Introduction to Phonetics and Phonology*. Oxford: Blackwell.
- Clements, George. 1985. The geometry of phonological features. *Phonology Yearbook* 2:225-52.
- Clements, G.N. 1987. Phonological feature representation and the description of intrusive stops. *Papers from the Twenty-third Meeting, Chicago Linguistics Society*, vol. 2, 29-50. Chicago: University of Chicago, Chicago Linguistics Society.
- . 1990. The role of the sonority cycle in core syllabification. *Papers in laboratory phonology I: between the grammar and physics of speech*, ed. by J. Kingston and M. Beckman, 283-333. Cambridge: Cambridge University Press.
- ., and Elizabeth V. Hume. 1995. The internal organization of speech sounds. *The handbook of phonological theory*, ed. by John A. Goldsmith, 245-306. Cambridge: Blackwell.
- Clumeck, Harold. 1975. A cross-linguistic investigation of vowel nasalization: an instrumental study. *Nasálfest: Papers from a symposium on nasals and nasalization*, ed. by C.A. Ferguson, L.M. Hyman, and J.J. Ohala, 133-52. Stanford: Stanford University Press.
- Cohn, Abigail C. 1990. Phonetic and phonological rules of nasalization. *UCLA Working papers in phonetics* #76. Los Angeles: UCLA.
- . 1993. A survey of the phonology of the feature [+/- nasal]. *Working Papers of the Cornell Phonetics Laboratory* 8:141-203. Ithaca, NY: Cornell University.
- Cohn, Abigail C. 1993. Nasalisation in English: phonology or phonetics. *Phonology* 10:43-81.
- Creissels, Denis. 1989. Lieu d'articulation de consonnes et des voyelles: une théorie unifiée. *L'architecture des représentations phonologiques*, ed. by Bernard Laks and Annie Riolland. Paris: CNRS Éditions.
- Crothers, John. 1975. Nasal consonant systems. *Nasálfest: Papers from a symposium on nasals and nasalization*, ed. by C.A. Ferguson, L.M. Hyman, and J.J. Ohala, 153-66. Stanford: Stanford University Press.
- Ferguson, C.A., L.M. Hyman, and J.J. Ohala. 1975. *Nasálfest: papers from a symposium on nasals and nasalization*. Stanford: Stanford University Press.
- Foris, David. 1973. Sochiapan Chinantec syllable structure. *International Journal of American Linguistics* 39:232-35.
- Fudge, Eric. 1969. Syllables. *Journal of Linguistics* 6:253-57.
- Gibson, Lorna. 1954. El sistema de parentesco Pame. *Ciencias Antropológicas*, ed. by Carmen Cook de Leonard, vol. 3, 77-82. México: Órgano oficial del Centro de

- Investigaciones Antropológicas de México.
- . 1956. Pame (Otomi) phonemics and morphophonemics. *International Journal of American Linguistics* 22:242-65.
- , and Doris Bartholomew. 1979. Pame noun inflection. *International Journal of American Linguistics* 45:309-22.
- Givón, Talmy. 1990. *Syntax: a functional-typological introduction*, vols. 1-2. Amsterdam: John Benjamins Press.
- Goldsmith, John. 1976. *Autosegmental phonology*. Cambridge, MA: MIT Ph.D. dissertation.
- . 1999. *Phonological theory: the essential readings*. Malden, MA.: Blackwell Publishers.
- Grimes, Barbara. 2000. *Ethnologue*. Dallas: SIL International.
- Hajek, John. 1997. *Universals of sound change in nasalization*. Oxford: Blackwell.
- Halle, Morris and Kenneth Stevens. 1971. A note on laryngeal features. *Quarterly progress report* 101, 198-212. Cambridge, MA.: MIT, research laboratory of electronics.
- , and G.N. Clements. 1983. *Problem book in Phonology: A workbook for introductory courses in linguistics and modern phonology*. Cambridge: MIT Press.
- Hayes, Bruce. 1989. Compensatory lengthening in moraic phonology. *Linguistic Inquiry* 20:253-306.
- . 1990. *Metrical Stress Theory*. Chicago: The University of Chicago Press.
- Henderson, James. 1995. Phonology and grammar of Yele, Papua New Guinea. *Pacific Linguistics*, series B-112, ed. by T.E. Dutton, A.K. Pawley, M.D. Ross, and D.T. Tryon, 1-109. Canberra: The Australian National University.
- Hendon, Rufus S. 1966. *The phonology and morphology of Ulu Muar Malay*. New Haven, CT.: Yale University, department of Anthropology.
- Hercus, L.A. 1972. The pre-stopped nasal and lateral consonants. *Anthropological Linguistics* 14:293-305.
- Herrera Z., Esther. 2000. Amuzgo and Zapotec: two more cases of laryngeally complex languages *Anthropological linguistics* 42:545-63.
- Hollenbach, Barbara Elaine. 1977. Phonetic vs. phonemic correspondence in two Trique dialects. In *Studies in Otomanguean phonology*, ed. by W.R. Merrifield, 35-67. Dallas: Summer Institute of Linguistics.
- . 1984. *The phonology and morphology of tone and laryngeals in Copala Trique*. Tucson: The University of Arizona, Ph.D. dissertation.
- Howe, Darin and Douglas Pulleybank. 2001. Patterns and timing of glottalisation. *Phonology* 18:45-80.

- Huffman, M. and R. Krakow. 1993. *Nasals, nasalization, and the velum*. San Diego: Academic Press.
- Hume, Elizabeth. 1994. *Front vowels, coronal consonants and their interaction in nonlinear phonology*. New York: Garland Publishing.
- . 1996. Coronal consonant, front vowel parallels in Maltese. *Natural language and linguistic theory* 14:163-203.
- Hyman, Larry M. 1975. *Phonology: theory and analysis*. New York: Holt, Rinehart and Winston.
- Itô, Junko. 1989. A prosodic theory of epenthesis. *Natural Language and Linguistic Theory* 7:217-59.
- Jakobson, Roman. 1941. *Aphasie und allgemeine Lautgesetze*. Selected writings, vol. 1, 328-401. The Hague: Mouton, 1971.
- Kager, René. 1999. *Optimality Theory*. Cambridge: Cambridge University Press.
- Kenstowicz, Micheal and Charles Kisseberth. 1977. *Topics in phonological theory*. New York: Academic Press.
- , and Charles Kisseberth. 1979. *Generative phonology*. San Diego: Academic Press.
- . 1994. *Phonology in Generative Grammar*. Oxford: Blackwell.
- Kingston, John. 1990. *Articulatory binding*. *Papers in laboratory phonology I: between the grammar and physics of speech*, ed. by J. Kingston and M. Beckman, 343-406. Cambridge: Cambridge University Press.
- Ladefoged, Peter. 1982. *A course in phonetics (second edition)*. New York: Harcourt Brace Jovanovich.
- , and Ian Maddieson. 1996. *The sounds of the world's languages*. Cambridge, Ms.: Blackwell.
- Lastra de Suárez, Yolanda. 1984. Chichimeco Jonaz. *Supplement to the Handbook of Middle American Indians*, ed. by Victoria Reifler Bricker, general editor, Munro S. Edmondson, volume editor, vol. 2, 20-42. Austin: University of Texas Press.
- . 1992. The present-day languages of Mexico: an overview. *International Journal of the Sociology of Language* 96:35-43.
- Leben, William. 1973. *Suprasegmental phonology*. Cambridge, MA: MIT Ph.D. dissertation.
- Lieberman, Phillip. 1977. *Speech physiology and acoustic phonetics: an introduction*. New York: Macmillan Publishing Co., Inc.
- Lindeman, Fredrik Otto. 1987. *Introduction to the laryngeal theory*. Oslo: Norwegian University Press.
- Lombardi, Linda. 1994. *Laryngeal features and laryngeal neutralization*. New York:

Garland Publishing.

- . 1995. Why Place and Voice are different: Constraint interactions and feature faithfulness in Optimality Theory. Ms., University of Maryland, College Park. [ROA-105, <http://roa.rutgers.edu>.]
- Longacre, Robert. 1952. Five phonemic pitch levels in Trique. *Acta Linguistica* 7:62-82.
- Lopes, Aurise Brandão and Steve Parker. 1999. Aspects of Yuhup phonology. *International Journal of American Linguistics* 65:324-42.
- Macaulay, Monica. 1987. Cliticization and the morphosyntax of Mixtec. *International Journal of American Linguistics* 53:115-35.
- , and Joseph C. Salmons. 1995. The phonology of glottalization in Mixtec. *International Journal of American Linguistics* 61:38-61.
- Maddieson, Ian. 1984. *Patterns of sounds*. Cambridge: Cambridge University Press.
- , and Peter Ladefoged. 1993. Phonetics of partially nasal consonants. Nasals, nasalization and the velum, *Phonetics and Phonology* 5, ed. by M.K. Huffman and R.A. Krakow, 225-49. San Diego: Academic Press.
- Manrique Castañeda, Leonardo. 1967. Jiliapan Pame. *The Handbook of Middle American Indians*, ed. by Robert Wauchope, general editor, Norman McQuown, volume editor, vol. 5, 331-48. Austin: University of Texas Press.
- Marlett, Stephen A., and Velma B. Pickett. 1987. The syllable structure and aspect morphology in Isthmus Zapotec. *International Journal of American Linguistics* 53:398-422.
- Matisoff, James A. 1975. Rhinoglottophilia: the mysterious connection between nasality and glottality. *Nasálfest: papers from a symposium on nasals and nasalization*. ed. by C.A. Ferguson, L.M. Hyman, and J.J. Ohala, 289-316. Stanford: Stanford University Press.
- McCarthy, John and Alan Prince. 1995. Faithfulness and reduplicative identity. From *Papers in Optimality Theory*, ed. by J. Beckman, L. Walsh Dickey, and S. Urbanczyk, 249-384. (University of Massachusetts occasional papers in linguistics 18). Amherst, MA.: Graduate Linguistics Students Association.
- , and ———. 1995. Prosodic morphology. *The handbook of phonological theory*, ed. by John A. Goldsmith, 318-66. Cambridge: Blackwell.
- Meechan, Marjory. 1990. Vowel clusters and the glottal stop in Villa Zapotec. *Cahiers Linguistiques d'Ottawa* 19:151-78.
- Merrifield, William R. 1977. *Studies in Otomanguean phonology*. Summer Institute of Linguistics Publications in linguistics, number 54. Dallas: Summer Institute of Linguistics.
- Mester, R. Armin, and Junko Itô. 1989. Feature predictability and underspecification:

- palatal prosody in Japanese mimetics. *Language* 65:258-93.
- Mohanan, K.P. 1986. *The theory of lexical phonology*. Dordrecht: Reidel Publishing.
- . 1995. The organization of the grammar. *The handbook of phonological theory*, ed. John A. Goldsmith, pp. 24-69. Cambridge: Blackwell.
- Odden, David. 1988. Anti antigemination and the OCP. *Linguistic Inquiry* 19:451-75
- Ohala, John. 1975. Phonetic explanations for nasal sound patterns. *Nasálfest: Papers from a symposium on nasals and nasalization*, ed. by C.A. Ferguson, L.M. Hyman, and J.J. Ohala, 289-316. Stanford: Stanford University Press.
- , and Manjari Ohala. 1993. Phonetics in nasal phonology. *Nasals, nasalization and the velum*, *Phonetics and Phonology* 5, ed. by M.K. Huffman and R.A. Krakow, 225-49. San Diego: Academic Press.
- Olson, Donald. 1963. Spanish loan words in Pame. *International Journal of American Linguistics* 29:219-21.
- Paradis, Carole, and Jean F. Prunet. 1991. The special status of coronals: internal and external evidence. *Phonetics and phonology* 2. San Diego: Academic Press.
- Paradis, Carole and Jean-François Prunet. 1993. A note on velar nasals: the case of Uradhi. *Canadian Journal of Linguistics*. 38(4):425-439.
- Parker, Steve, and David Weber. 1996. Glottalized and aspirated stops in Cuzco Quechua. *International Journal of American Linguistics* 62:70-85.
- . 1997. An OT account of laryngealization in Cuzco Quechua. *Work Papers of the Summer Institute of Linguistics and the University of North Dakota* 41:46-56.
- . 1999. A sketch of Iñapari phonology. *International Journal of American Linguistics* 65:1-39.
- Payne, David L. 1981. *The phonology and morphology of Axininca Campa*. Dallas, TX: Summer Institute of Linguistics.
- Pickett, J.M. 1999. *The acoustics of speech communication: fundamentals, speech, perception theory, and technology*. Boston: Allyn & Bacon.
- Piggott, Glyne L., and Rajendra Singh. 1985. The phonology of epenthetic segments. *Canadian Journal of Linguistics* 30:415-51.
- . 1992. Variability and feature dependency: the case of nasality. *Natural Language and Linguistic Theory* 10:33-77.
- Pike, Kenneth L. 1947. *Phonemics: A technique for reducing language to writing*. Ann Arbor, MI: The University of Michigan Press.
- , and Eunice V. Pike. 1947. Immediate constituents of Mazateco syllables. *International Journal of American Linguistics* 13:78-91.
- Prince, Alan, and Paul Smolensky. 1993. *Optimality Theory: constraint interaction in*

- generative grammar. New Brunswick, NJ and Boulder, CO: Rutgers University and University of Colorado, ms.
- Pulleyblank, Douglas. 1997. Optimality theory and features. *Optimality Theory: an overview*, ed. by D. Archangeli and D.T. Langendoen, 59-101. Oxford: Blackwell.
- Rench, Calvin R. 1978. Ballistic and controlled syllables in Otomanguean languages. *Syllables and Segment*, ed. by Alan Bell and Joan Bybee Hooper, 85-92. Amsterdam: North Holland Publishing Company.
- Sagey, Elizabeth. 1990. *The representation of features in non-linear phonology*. New York: Garland Publishing Company.
- Scott, N.C. 1964. Nasal consonants in Land Dayak (Bukar-Sadong). In honour of Daniel Jones, ed. by D. Abercrombie. London: Longmans.
- Selkirk, Elisabeth. 1980. The role of prosodic categories in English word stress. *Linguistic Inquiry* 11.563-605.
- . 1982. The syllable. *The structure of phonological representations II*, ed. by H. van der Hulst and N. Smith, 337-83. Dordrecht: Foris.
- Silverman, Daniel, Barbara Blankenship, Paul Kirk, and Peter Ladefoged. 1995. Phonetic structures in Jalapa Mazatec. *Anthropological linguistics* 37:70-88.
- . 1997a. Phasing and Recoverability. *UCLA occasional papers in linguistics, dissertation series #1*. Los Angeles, CA: UCLA Ph.D. dissertation.
- . 1997b. Laryngeal complexity in Otomanguean vowels. *Phonology* 14:235-61.
- Soustelle, Jacques. 1937. *La familia Otomí-Pame del México central*. Mexico: Fondo de cultura económica, 1993.
- Spencer, Andrew. 1991. *Morphological theory: an introduction to word structure in generative grammar*. Oxford: Blackwell.
- Steriade, Donca. 1994. Complex onsets as single segments: the Mazateco pattern. *Perspectives in Phonology*, ed. by J. Cole and C. Kisseberth, 203-292. Stanford: CSLI.
- . 1995. Underspecification and markedness. *The handbook of phonological theory*, ed. by John A. Goldsmith, 114-74. Cambridge: Blackwell.
- Stevens, K.N. 2000. *Acoustic phonetics*. Cambridge: MIT.
- Van der Hulst, Harry, and Jeroen Van de Weijer. 1995. Vowel harmony. *The handbook of phonological theory*, ed. by John A. Goldsmith, 495-534. Cambridge: Blackwell.
- Wetzels, W. Leo. 1985. The historical phonology of intrusive stops. A nonlinear description. *Canadian Journal of Linguistics* 30:285-33.
- Yip, Moira. 1982. Against a segmental analysis of Zhaao and Thai: A laryngeal tier proposal. *Linguistic Analysis* 9:79-94.
- . 1989. Feature geometry and co-occurrence restrictions. *Phonology* 6.349-74.

———. 1995. Tone in East Asian languages. *The Handbook of Phonological theory*, ed. by John A. Goldsmith, 476-94. Cambridge: Blackwell.

BIOGRAPHICAL INFORMATION

Scott Berthiaume earned a Bachelors of Arts (Biblical Studies) in 1990, a Master of Arts (Linguistics) in 1994 and a Ph.D. (Linguistics) 2003. Since 1996, he has been involved in linguistic research and missionary work among the Northern Pame people of Central Mexico and is a member with his wife of the Summer Institute of Linguistics.

His primary linguistic interests lie in the domains of phonology and morphology, and their interpretation from a multi-theoretical perspective. In addition, the author has published in areas related to nasalization in Otomanguean and Otopamean languages.

